

# GCSE

Specification

## Physics M (modular)

For schools outside England

For exams January 2013 onwards

For certification June 2014





**GCSE**

**Specification**

**Physics M (modular)**

**4603**

This specification is published on the AQA website ([www.aqa.org.uk](http://www.aqa.org.uk)). We will let centres know in writing about any changes to the specification. We will also publish changes on our website. The version on the website is the definitive version; this may differ from printed versions.

Further copies of this specification booklet are available from:

AQA Logistics Centre (Manchester), Unit 2, Wheel Forge Way, Ashburton Park,  
Trafford Park, Manchester, M17 1EH

Or, you can download a copy from the AQA website: [www.aqa.org.uk](http://www.aqa.org.uk)

Copyright © 2012 AQA and its licensors. All rights reserved.

#### COPYRIGHT

AQA retains the copyright on all its publications, including the specifications. However, registered centres for AQA are permitted to copy material from this specification booklet for their own internal use, with the following important exception: AQA cannot give permission to centres to photocopy any material that is acknowledged to a third party even for internal use within the centre.

Set and published by the Assessment and Qualifications Alliance.

The Assessment and Qualifications Alliance (AQA) is a company limited by guarantee, registered in England and Wales (company number 3644723) and a registered charity (registered charity number 1073334).  
Registered address: AQA, Devas Street, Manchester, M15 6EX

# Contents

<b>1</b>	<b>Introduction</b>	<b>2</b>
1.1	Why choose AQA?	2
1.2	Why choose GCSE Physics M (modular)?	3
1.3	How do I start using this specification?	4
1.4	How can I find out more?	4
<b>2</b>	<b>Specification at a Glance</b>	<b>5</b>
<b>3</b>	<b>Subject Content</b>	<b>6</b>
3.1	Introduction to Subject Content	6
3.2	How Science Works	7
3.3	Unit 1: Physics 1 MPH1	10
3.4	Unit 2: Physics 2 MPH2	20
3.5	Unit 3: Physics 3 MPH3	36
3.6	Unit 4: Controlled Assessment MPH4	45
3.7	Mathematical and other requirements	52
<b>4</b>	<b>Scheme of Assessment</b>	<b>53</b>
4.1	Aims and learning outcomes	53
4.2	Assessment Objectives	54
4.3	National criteria	54
4.4	Previous Learning requirements	55
4.5	Access to assessment: diversity and inclusion	55
<b>5</b>	<b>Administration</b>	<b>56</b>
5.1	Availability of assessment units and certification	56
5.2	Entries	56
5.3	Private candidates	56
5.4	Access arrangements, reasonable adjustments and special consideration	57
5.5	Examination language	57
5.6	Qualification titles	57
5.7	Awarding grades and reporting results	58
5.8	Grading and tiers	59
5.9	Re-sits and shelf life of unit results	60
<b>6</b>	<b>Controlled Assessment administration</b>	<b>61</b>
6.1	Authentication of Controlled Assessment work	61
6.2	Malpractice	61
6.3	Teacher standardisation	62
6.4	Internal standardisation of marking	62
6.5	Annotation of Controlled Assessment work	62
6.6	Submitting marks and sample work for moderation	63
6.7	Factors affecting individual candidates	63
6.8	Keeping candidates' work	63
6.9	Grade boundaries on Controlled Assessment	63
<b>7</b>	<b>Moderation</b>	<b>64</b>
7.1	Moderation procedures	64
7.2	Consortium arrangements	64
7.3	Procedures after moderation	64
	<b>Appendices</b>	<b>65</b>
A	Grade descriptions	65
B	Spiritual, moral, ethical, social, legislative, sustainable development, economic and cultural issues, and health and safety considerations	66
C	Overlaps with other qualifications	67
D	Wider Key Skills	68

# Introduction

## 1.1 Why choose AQA?

We, AQA, are the United Kingdom's favourite awarding body and more candidates get their academic qualifications from us than from any other body. But why are we so popular?



**We understand the different requirements of each subject by working with teachers. Our GCSEs:**

- help candidates to achieve their full potential
- are relevant for today's challenges
- are manageable for schools and colleges
- are easy for candidates of all levels of ability to understand
- lead to accurate results, delivered on time
- are affordable and value for money.

**We provide a wide range of support services for teachers, including:**

- access to subject departments
- training for teachers, including practical teaching strategies and methods that work, presented by senior examiners
- individual support for Controlled Assessment
- 24-hour support through our website and online with **Ask AQA**
- past question papers and mark schemes
- a wide range of printed and electronic resources for teachers and candidates
- free online results analysis, with Enhanced Results Analysis.

**We are an educational charity focused on the needs of the learner. All our income is spent on improving the quality of our specifications, examinations and support services. We don't aim to profit from education, we want you to.**

If you are already a customer we thank you for your support. If you are thinking of joining us we look forward to welcoming you.

## 1.2 Why choose GCSE Physics M (modular)?

GCSE Physics M (modular) enables you to provide a Key Stage 4 physics course for learners of any ability, whether they intend to study science further or not. The specification has three physics teaching and learning units and a Controlled Assessment unit. The model of Controlled Assessment, Investigative Skills Assignment (ISA), is straightforward and the previous version proved popular with teachers. This course provides a firm foundation for progression to AS and A level Physics. GCSE Physics M (modular) is identical in subject content to GCSE Physics but is assessed in a modular way. Examinations in GCSE Physics M (modular) are not available in England.

During the development of our specifications, we have been careful to ensure natural progression from KS3 and we have paid attention to the Assessing Pupils' Progress (APP) approach developed by QCDA and the National Strategies. In Unit 4, we have signposted the assessment focus threads to match those used in KS3.

When our science AS and A-levels were developed for first teaching from September 2008, we were very careful to ensure that there was no 'gap' so that learners could easily progress from KS4. We used the same model of internal assessment (ISAs). Research into the outcomes of learners at GCSE and A-level has shown that we were successful in ensuring a smooth transition. A-levels are due to be redeveloped to follow from this GCSE development, and we will continue to ensure our portfolio of specifications offers good progression routes.

GCSE Physics M (modular) is one of many qualifications that AQA offers for Key Stage 4. AQA's range, which includes GCSEs, Diplomas and Entry Level qualifications, enables teachers to select and design appropriate courses for all learners.

In addition to this specification and the associated specimen papers, we offer a wide range of related support and resources for teachers, much of it free.

This includes:

- Preparing to Teach meetings
- on-line schemes of work
- ideas for practical work including worksheets and technician guidance
- practice tests for homework
- our Enhanced Results Analysis service.

This support is accessible through a web-based portal called *The Science Lab*.



## 1.3 How do I start using this specification?

To ensure you receive all the teaching and examination material, it is important that the person responsible for making the decision to teach AQA informs both AQA and their Examinations Officer.

### Step One

To confirm you will be teaching this specification please sign up to teach and complete the online form. You will then receive your free GCSE Sciences welcome pack(s) that contain teaching and support material.

### Step Two

Inform your Examinations Officer of your choice to ensure you receive all your examination material. Your Examinations Officer will make sure that your centre is registered with AQA and will complete the *Intention to Enter* and *Estimated Entries* when required to do so.

If your centre has not used AQA for any examinations in the past, please contact our centre approval team at [centreapproval@aqa.org.uk](mailto:centreapproval@aqa.org.uk)

## 1.4 How can I find out more?

You can choose to find out more about this specification or the services that AQA offers in a number of ways.

### Ask AQA

We provide 24-hour access to useful information and answers to the most commonly asked questions at [www.aqa.org.uk/askaqa](http://www.aqa.org.uk/askaqa)

If the answer to your question is not available, you can submit a query through **Ask AQA** and we will respond within two working days.

### Speak to your subject team

You can talk directly to the GCSE Sciences subject team about this specification on **01483 477 756** or e-mail [science-gcse@aqa.org.uk](mailto:science-gcse@aqa.org.uk)

### Teacher Support

Details of the full range of our Teacher Support and CPD courses are available on our website at [www.aqa.org.uk/qual/cpd](http://www.aqa.org.uk/qual/cpd)

There is also a link to our fast and convenient online booking system for all of our courses at [coursesandevents.aqa.org.uk/training](http://coursesandevents.aqa.org.uk/training)

### Latest information online

You can find out more including the latest news, how to register to use Enhanced Results Analysis, support and downloadable resources on our website at [www.aqa.org.uk](http://www.aqa.org.uk)

# Specification at a Glance

## Unit 1: Physics 1

Written paper – **1 hour**

60 marks – **25%**

### Structured and closed questions

At least one question assessing Quality of Written Communication in a science context.



## Unit 2: Physics 2

Written paper – **1 hour**

60 marks – **25%**

### Structured and closed questions

At least one question assessing Quality of Written Communication in a science context.



## Unit 3: Physics 3

Written paper – **1 hour**

60 marks – **25%**

### Structured and closed questions

At least one question assessing Quality of Written Communication in a science context.



## Unit 4: Controlled Assessment

Investigative Skills Assignment – two written assessments plus one or two lessons for practical work and data processing.

50 marks – **25%**

### Controlled Assessment:

- we set the ISAs and send you all the information before the course starts
- you choose which of several ISAs to do and when
- your candidates do the ISA test in class time
- you mark their tests using marking guidance from us
- we moderate your marks.

Examinations in this subject are not available in England



# Subject Content

## 3.1 Introduction to Subject Content

The subject content of this specification is presented in five sections:

- How Science Works
- the three sections of substantive content, Physics 1, Physics 2, Physics 3
- and the Controlled Assessment (Unit 4).

It is intended that the How Science Works content is integrated and delivered not only through the Controlled Assessment but also through the context of the content of **Physics 1**, **Physics 2** and **Physics 3**.

The organisation of each sub-section of the substantive content is designed to facilitate this approach. Each of the sub-sections of Physics 1, Physics 2 and Physics 3 starts with the statement:

---

**‘Candidates should use their skills, knowledge and understanding to:’.**

This introduces a number of activities, for example:

- **evaluate different methods of generating electricity.**

---

These activities are intended to enable candidates to develop the skills, knowledge and understanding of How Science Works.

Other aspects of the skills, knowledge and understanding of How Science Works will be better developed through investigative work and it is expected that teachers will adopt a practical enquiry approach to the teaching of many topics.

The subject content is presented in two columns. The left-hand column lists the content that needs to be delivered. The right-hand column contains guidance

and expansion of the content to aid teachers in delivering it and gives further details on what will be examined.

At the end of each section there is a list of ideas for investigative practical work that could be used to help candidates develop their practical enquiry skills to understand and engage with the content.

Opportunities to carry out practical work should be provided in the context of each section. These opportunities should allow candidates to:

- use their knowledge and understanding to pose scientific questions and define scientific problems
- plan and carry out investigative activities, including appropriate risk management, in a range of contexts
- collect, select, process, analyse and interpret both primary and secondary data to provide evidence
- evaluate their methodology, evidence and data.

In the written papers, questions will be set that examine How Science Works in physics contexts.

Examination questions will use examples that are both familiar and unfamiliar to candidates. All applications will use the knowledge and understanding developed through the substantive content.

### Tiering of subject content

In this specification there is additional content for Higher Tier candidates. This is denoted in the subject content in **bold type** and annotated as **HT only** in Sections 3.3 to 3.5.



## 3.2 How Science Works

This section is the content underpinning the science that candidates need to know and understand. Candidates will be tested on How Science Works in **both** written papers and the Controlled Assessment.

The scientific terms used in this section are clearly defined by the ASE in *The Language of Measurement: Terminology used in school science investigations* (Association for Science Education, 2010). Teachers should ensure that they, and their candidates, are familiar with these terms. Definitions of the terms will **not** be required in assessments, but candidates will be expected to use them correctly.

### The thinking behind the doing

Science attempts to explain the world in which we live. It provides technologies that have had a great impact on our society and the environment. Scientists try to explain phenomena and solve problems using evidence. The data to be used as evidence must be repeatable, reproducible and valid, as only then can appropriate conclusions be made.

A scientifically literate person should, amongst other things, be equipped to question, and engage in debate on, the evidence used in decision-making.

The repeatability and the reproducibility of evidence refers to how much we trust the data. The validity of evidence depends on these, as well as on whether the research answers the question. If the data is not repeatable or reproducible the research cannot be valid.

To ensure the repeatability, reproducibility and validity of evidence, scientists consider a range of ideas that relate to:

- how we observe the world
- designing investigations so that patterns and relationships between variables may be identified
- making measurements by selecting and using instruments effectively
- presenting and representing data
- identifying patterns and relationships and making suitable conclusions.

These ideas inform decisions and are central to science education. They constitute the 'thinking behind the doing' that is a necessary complement to the subject content of biology, chemistry and physics.

### Fundamental ideas

Evidence must be approached with a critical eye. It is necessary to look closely at how measurements have been made and what links have been established. Scientific evidence provides a powerful means of forming opinions. These ideas pervade all of How Science Works.

- It is necessary to distinguish between opinion based on valid, repeatable and reproducible evidence and opinion based on non-scientific ideas (prejudices, whim or hearsay).
- Scientific investigations often seek to identify links between two or more variables. These links may be:
  - causal, in that a change in one variable causes a change in another
  - due to association, in that changes in one variable and a second variable are linked by a third variable
  - due to chance occurrence.
- Evidence must be looked at carefully to make sure that it is:
  - repeatable
  - reproducible
  - valid.

### Observation as a stimulus to investigation

Observation is the link between the real world and scientific ideas. When we observe objects, organisms or events we do so using existing knowledge. Observations may suggest hypotheses that can be tested.

- A hypothesis is a proposal intended to explain certain facts or observations.
- A prediction is a statement about the way something will happen in the future.
- Observations can lead to the start of an investigation, experiment or survey. Existing models can be used creatively to suggest explanations for observations (hypotheses). Careful observation is necessary before deciding which variables are the most important. Hypotheses can then be used to make predictions that can be tested.
- Data from testing a prediction can support or refute the hypothesis or lead to a new hypothesis.
- If the hypotheses and models we have available to us do not completely match our data or observations, we need to check the validity of our observations or data, or amend the models.



### Designing an investigation

An investigation is an attempt to determine whether or not there is a relationship between variables. It is therefore necessary to identify and understand the variables in an investigation. The design of an investigation should be scrutinised when evaluating the validity of the evidence it has produced.

- An independent variable is one that is changed or selected by the investigator. The dependent variable is measured for each change in the independent variable.
- For a measurement to be valid it must measure only the appropriate variable.
- A fair test is one in which only the independent variable affects the dependent variable, as all other variables are kept the same. These are called control variables.
- When using large-scale survey results, it is necessary to select data from conditions that are similar.
- Control groups are often used in biological and medical research to ensure that observed effects are due to changes in the independent variable alone.
- Care is needed in selecting values of variables to be recorded in an investigation. A trial run will help identify appropriate values to be recorded, such as the number of repeated readings needed and their range and interval.

- An accurate measurement is one that is close to the true value.
- The design of an investigation must provide data with sufficient precision to form a valid conclusion.

### Making measurements

When making measurements we must consider such issues as inherent variation due to variables that have not been controlled, human error and the characteristics of the instruments used. Evidence should be evaluated with the repeatability and validity of the measurements that have been made in mind.

- There will always be some variation in the actual value of a variable, no matter how hard we try to repeat an event.
- The resolution of an instrument refers to the smallest change in a value that can be detected.
- Even when an instrument is used correctly, human error may occur; this could produce random differences in repeated readings or a systematic shift from the true value.
- Random error can result from inconsistent application of a technique. Systematic error can result from consistent misapplication of a technique.
- Any anomalous values should be examined to try to identify the cause and, if a product of a poor measurement, ignored.

### Presenting data

To explain the relationship between two or more variables, data may be presented in such a way as to make the patterns more evident. There is a link between the type of graph used and the type of variable represented. The choice of graphical representation depends upon the type of variable represented.

- The range of the data refers to the maximum and minimum values.
- The mean (or average) of the data refers to the sum of all the measurements divided by the number of measurements taken.
- Tables are an effective means of displaying data but are limited in how they portray the design of an investigation.
- Bar charts can be used to display data in which one of the variables is categorical.
- Line graphs can be used to display data in which both the independent and dependent variables are continuous.
- Scattergrams can be used to show an association between two variables.



### Using data to draw conclusions

The patterns and relationships observed in data represent the behaviour of the variables in an investigation. However, it is necessary to look at patterns and relationships between variables with the limitations of the data in mind in order to draw conclusions.

- Patterns in tables and graphs can be used to identify anomalous data that require further consideration.
- A line of best fit can be used to illustrate the underlying relationship between variables.
- Conclusions must be limited by, and not go beyond, the data available.

### Evaluation

In evaluating a whole investigation the repeatability, reproducibility and validity of the data obtained must be considered.

### Societal aspects of scientific evidence

A judgement or decision relating to social-scientific issues may not be based on evidence alone, as other societal factors may be relevant.

- Evidence must be scrutinised for any potential bias of the experimenter, such as funding sources or allegiances.
- Evidence can be accorded undue weight, or dismissed too lightly, simply because of its political significance. If the consequences of the evidence could provoke public or political disquiet, the evidence may be downplayed.
- The status of the experimenter may influence the weight placed on evidence; for instance, academic or professional status, experience and authority.

- Scientific knowledge gained through investigations can be the basis for technological developments.
- Developments in science and technology have ethical, social, economic or environmental consequences, which should always be taken into account when evaluating the impacts of any new developments.
- Advancements in science can have ethical implications. The effects of these must be taken into account in a balanced way to facilitate decision making.
- Decisions are made by individuals and by society on issues relating to science and technology.

### Limitations of scientific evidence

Science can help us in many ways but it cannot supply all the answers.

- We are still finding out about things and developing our scientific knowledge.
- There are some questions that we cannot answer, maybe because we do not have enough repeatable, reproducible and valid evidence.
- There are some questions that science cannot answer directly. These tend to be questions where beliefs, opinions and ethics are important.



### 3.3 Unit 1: Physics 1

#### P1.1 The transfer of energy by heating processes and the factors that affect the rate at which that energy is transferred

Energy can be transferred from one place to another by work or by heating processes. We need to know how this energy is transferred and which heating processes are most important in a particular situation.

##### Candidates should use their skills, knowledge and understanding to:

- compare ways in which energy is transferred in and out of objects by heating and ways in which the rates of these transfers can be varied
- evaluate the design of everyday appliances that transfer energy by heating, including economic considerations
- evaluate the effectiveness of different types of material used for insulation, including U-values and economic factors including payback time
- evaluate different materials according to their specific heat capacities.

##### Additional guidance:

Examples should include the design of a vacuum flask, how to reduce the energy transfer from a building and how humans and animals cope with low temperatures.

Examples include radiators and heat sinks.

Examples include loft insulation and cavity wall insulation.

Examples include the use of water, which has a very high specific heat capacity, oil-filled radiators and electric storage heaters containing concrete or bricks.

##### P1.1.1 Infrared radiation

- a) All objects emit and absorb infrared radiation.
- b) The hotter an object is the more infrared radiation it radiates in a given time.
- c) Dark, matt surfaces are good absorbers and good emitters of infrared radiation.
- d) Light, shiny surfaces are poor absorbers and poor emitters of infrared radiation.
- e) Light, shiny surfaces are good reflectors of infrared radiation.

### P1.1.2 Kinetic theory

- a) The use of kinetic theory to explain the different states of matter.
- b) The particles of solids, liquids and gases have different amounts of energy.

#### Additional guidance:

Candidates should be able to recognise simple diagrams to model the difference between solids, liquids and gases.

An understanding of specific latent heat is **not** required.

### P1.1.3 Energy transfer by heating

- a) The transfer of energy by conduction, convection, evaporation and condensation involves particles, and how this transfer takes place.
- b) The factors that affect the rate of evaporation and condensation.
- c) The rate at which an object transfers energy by heating depends on:
- surface area and volume
  - the material from which the object is made
  - the nature of the surface with which the object is in contact.
- d) The bigger the temperature difference between an object and its surroundings, the faster the rate at which energy is transferred by heating.

#### Additional guidance:

Candidates should understand in simple terms how the arrangement and movement of particles determine whether a material is a conductor or an insulator.

Candidates should understand the role of free electrons in conduction through a metal.

Candidates should be able to use the idea of particles moving apart to make a fluid less dense, to explain simple applications of convection.

Candidates should be able to explain evaporation and the cooling effect this causes using the kinetic theory.

Candidates should be able to explain the design of devices in terms of energy transfer, for example, cooling fins.

Candidates should be able to explain animal adaptations in terms of energy transfer, for example, relative ear size of animals in cold and warm climates.

### P1.1.4 Heating and insulating buildings

a) U-values measure how effective a material is as an insulator.

#### Additional guidance:

Knowledge of the U-values of specific materials is **not** required, nor is the equation that defines a U-value.

b) The lower the U-value, the better the material is as an insulator.

c) Solar panels may contain water that is heated by radiation from the Sun. This water may then be used to heat buildings or provide domestic hot water.

d) The specific heat capacity of a substance is the amount of energy required to change the temperature of one kilogram of the substance by one degree Celsius.

$$E = m \times c \times \theta$$

#### Additional guidance:

$E$  is energy transferred in joules, J

$m$  is mass in kilograms, kg

$\theta$  is temperature change in degrees Celsius, °C

$c$  is specific heat capacity in J/kg °C

#### Suggested ideas for practical work to develop skills and understanding include the following:

- passing white light through a prism and detecting the infrared radiation with a thermometer
- demonstration using balls in a tray to show the behaviour of particles in substances in different states
- measuring the cooling effect produced by evaporation; putting wet cotton wool over the bulb of a thermometer or temperature probe
- plan and carry out an investigation into factors that affect the rate of cooling of a can of water, eg shape, volume, and colour of can
- using Leslie's cube to demonstrate the effect on radiation of altering the nature of the surface
- plan and carry out an investigation using immersion heaters in a metal block to measure specific heat capacity
- investigating thermal conduction using rods of different materials.



## P1.2 Energy and efficiency

Appliances transfer energy but they rarely transfer all of the energy to the place we want. We need to know the efficiency of appliances so that we can choose between them, including how cost effective they are, and try to improve them.

### Candidates should use their skills, knowledge and understanding to:

- compare the efficiency and cost effectiveness of methods used to reduce 'energy consumption'

- describe the energy transfers and the main energy wastages that occur with a range of appliances

- interpret and draw a Sankey diagram.

### Additional guidance:

The term 'pay-back time' should be understood.

Given relevant data, candidates should be able to make judgements about the cost effectiveness of different methods of reducing energy consumption over a set period of time. This is **not** restricted to a consideration of building insulation but may include:

- low energy light bulbs and LED lighting
- replacing old appliances with energy efficient ones
- ways in which 'waste' energy can be useful, eg heat exchangers.

Common electrical appliances found in the home will be examined. Examples will **not** be limited to electrical appliances; however, in this case all the information would be given in the question.

Candidates should be able to use a Sankey diagram to calculate the efficiency of an appliance.

### P1.2.1 Energy transfers and efficiency

- Energy can be transferred usefully, stored, or dissipated, but cannot be created or destroyed.
- When energy is transferred only part of it may be usefully transferred, the rest is 'wasted'.
- Wasted energy is eventually transferred to the surroundings, which become warmer. The wasted energy becomes increasingly spread out and so becomes less useful.

- d) To calculate the efficiency of a device using:

$$\text{efficiency} = \frac{\text{useful energy out}}{\text{total energy in}} (\times 100\%)$$

$$\text{efficiency} = \frac{\text{useful power out}}{\text{total power in}} (\times 100\%)$$

#### Additional guidance:

Candidates may be required to calculate efficiency as a decimal or as a percentage.

#### Suggested ideas for practical work to develop skills and understanding include the following:

- an energy 'circus' to demonstrate various energy transfers
- plan and carry out an investigation by constructing a model house, using sensors and data logger to measure temperatures with and without various types of insulation.

### P1.3 The usefulness of electrical appliances

We often use electrical appliances because they transfer energy at the flick of a switch. We can calculate how much energy is transferred by an appliance and how much the appliance costs to run.

#### Candidates should use their skills, knowledge and understanding to:

- compare the advantages and disadvantages of using different electrical appliances for a particular application
- consider the implications of instances when electricity is not available.

#### Additional guidance:

Candidates will be required to compare different electrical appliances, using data provided.

#### P1.3.1 Transferring electrical energy

- a) Examples of energy transfers that everyday electrical appliances are designed to bring about.
- b) The amount of energy an appliance transfers depends on how long the appliance is switched on and its power.

- c) To calculate the amount of energy transferred from the mains using:

$$E = P \times t$$

#### Additional guidance:

Candidates will **not** be required to convert between kilowatt-hours and joules.

$E$  is energy transferred in kilowatt-hours, kWh

$P$  is power in kilowatts, kW

$t$  is time in hours, h

This equation may also be used when:

$E$  is energy transferred in joules, J

$P$  is power in watts, W

$t$  is time in seconds, s

- d) To calculate the cost of mains electricity given the cost per kilowatt-hour.

**Additional guidance:**

This includes both the cost of using individual appliances and the interpretation of electricity meter readings to calculate total cost over a period of time.

**Suggested ideas for practical work to develop skills and understanding include the following:**

- candidates reading the electricity meter at home on a daily or weekly basis. They could then look for trends in usage and try to explain these, eg in terms of weather conditions
- plan and carry out an investigation using an electrical joulemeter to measure the energy transferred by low voltage bulbs of different powers, low voltage motors and low voltage immersion heaters.

## P1.4 Methods we use to generate electricity

Various energy sources can be used to generate the electricity we need. We must carefully consider the advantages and disadvantages of using each energy source before deciding which energy source(s) it would be best to use in any particular situation. Electricity is distributed via the National Grid.

**Candidates should use their skills, knowledge and understanding to:**

- evaluate different methods of generating electricity

**Additional guidance:**

Candidates should be able to evaluate different methods of generating electricity given data including start-up times, costs of electricity generation and the total cost of generating electricity when factors such as building and decommissioning are taken into account. The reliability of different methods should also be understood.

Knowledge of the actual values of start-up times and why they are different is **not** needed, but the implications of such differences are important.

- evaluate ways of matching supply with demand, either by increasing supply or decreasing demand

Candidates should be aware of the fact that, of the fossil fuel power stations, gas-fired have the shortest start-up time. They should also be aware of the advantages of pumped storage systems in order to meet peak demand, and as a means of storing energy for later use.

- compare the advantages and disadvantages of overhead power lines and underground cables.

### P1.4.1 Generating electricity

- a) In some power stations an energy source is used to heat water. The steam produced drives a turbine that is coupled to an electrical generator.

Energy sources include:

- the fossil fuels (coal, oil and gas) which are burned to heat water or air
- uranium and plutonium, when energy from nuclear fission is used to heat water
- biofuels that can be burned to heat water.

b) Water and wind can be used to drive turbines directly.

**Additional guidance:**

Energy sources used in this way include, but are not limited to, wind, waves, tides and the falling of water in hydroelectric schemes.

c) Electricity can be produced directly from the Sun's radiation.

Candidates should know that solar cells can be used to generate electricity and should be able to describe the advantages and disadvantages of their use.

d) In some volcanic areas hot water and steam rise to the surface. The steam can be tapped and used to drive turbines. This is known as geothermal energy.

e) Small-scale production of electricity may be useful in some areas and for some uses, eg hydroelectricity in remote areas and solar cells for roadside signs.

**Additional guidance:**

Candidates should understand that while small-scale production can be locally useful it is sometimes uneconomic to connect such generation to the National Grid.

f) Using different energy resources has different effects on the environment. These effects include:

- the release of substances into the atmosphere
- the production of waste materials
- noise and visual pollution
- the destruction of wildlife habitats.

Candidates should understand that carbon capture and storage is a rapidly evolving technology. To prevent carbon dioxide building up in the atmosphere we can catch and store it. Some of the best natural containers are old oil and gas fields, such as those under the North Sea.

### P1.4.2 The National Grid

a) Electricity is distributed from power stations to consumers along the National Grid.

**Additional guidance:**

Candidates should be able to identify and label the essential parts of the National Grid.

b) For a given power increasing the voltage reduces the current required and this reduces the energy losses in the cables.

Candidates should know why transformers are an essential part of the National Grid.

c) The uses of step-up and step-down transformers in the National Grid.

Details of the structure of a transformer and how a transformer works are **not** required.

**Suggested ideas for practical work to develop skills and understanding include the following:**

- investigating the effect of changing different variables on the output of solar cells, eg distance from the light source, the use of different coloured filters and the area of the solar cells
- planning and carrying out an investigation into the effect of changing different variables on the output of model wind turbines, eg the number or pitch of the blades, the wind velocity
- demonstrating a model water turbine linked to a generator
- modelling the National Grid.

## P1.5 The use of waves for communication and to provide evidence that the universe is expanding

Electromagnetic radiations travel as waves and move energy from one place to another. They can all travel through a vacuum and do so at the same speed. The waves cover a continuous range of wavelengths called the electromagnetic spectrum.

Sound waves and some mechanical waves are longitudinal, and cannot travel through a vacuum.

Current evidence suggests that the universe is expanding and that matter and space expanded violently and rapidly from a very small initial 'point', ie the universe began with a 'big bang'.

### Candidates should use their skills, knowledge and understanding to:

- compare the use of different types of waves for communication
- evaluate the possible risks involving the use of mobile phones
- consider the limitations of the model that scientists use to explain how the universe began and why the universe continues to expand.

#### Additional guidance:

Knowledge and understanding of waves used for communication is limited to sound, light, microwaves, radio waves and infrared waves.

### P1.5.1 General properties of waves

a) Waves transfer energy.

b) Waves may be either transverse or longitudinal.

c) Electromagnetic waves are transverse, sound waves are longitudinal and mechanical waves may be either transverse or longitudinal.

d) All types of electromagnetic waves travel at the same speed through a vacuum (space).

e) Electromagnetic waves form a continuous spectrum.

f) Longitudinal waves show areas of compression and rarefaction.

#### Additional guidance:

Candidates should understand that in a transverse wave the oscillations are perpendicular to the direction of energy transfer. In a longitudinal wave the oscillations are parallel to the direction of energy transfer.

#### Additional guidance:

Candidates should know the order of electromagnetic waves within the spectrum, in terms of energy, frequency and wavelength.

Candidates should appreciate that the wavelengths vary from about  $10^{-15}$  metres to more than  $10^4$  metres.

g) Waves can be reflected, refracted and diffracted.

**Additional guidance:**

Candidates should appreciate that significant diffraction only occurs when the wavelength of the wave is of the same order of magnitude as the size of the gap or obstacle.

h) Waves undergo a change of direction when they are refracted at an interface.

Waves are not refracted if travelling along the normal. Snell's law and the reason why waves are refracted are **not** required.

i) The terms frequency, wavelength and amplitude.

j) All waves obey the wave equation:

$$v = f \times \lambda$$

**Additional guidance:**

$v$  is speed in metres per second, m/s

$f$  is frequency in hertz, Hz

$\lambda$  is wavelength in metres, m

Candidates are **not** required to recall the value of the speed of electromagnetic waves through a vacuum.

k) Radio waves, microwaves, infrared and visible light can be used for communication.

Candidates will be expected to be familiar with situations in which such waves are typically used and any associated hazards, eg:

- radio waves – television, and radio (including diffraction effects)
- microwaves – mobile phones and satellite television
- infrared – remote controls
- visible light – photography.

### P1.5.2 Reflection

a) The normal is a construction line perpendicular to the reflecting surface at the point of incidence.

b) The angle of incidence is equal to the angle of reflection.

**Additional guidance:**

c) The image produced in a plane mirror is virtual.

Candidates will be expected to be able to construct ray diagrams.

### P1.5.3 Sound

a) Sound waves are longitudinal waves and cause vibrations in a medium, which are detected as sound.

**Additional guidance:**

Sound is limited to human hearing and **no** details of the structure of the ear are required.

- b) The pitch of a sound is determined by its frequency and loudness by its amplitude.
- c) Echoes are reflections of sounds.

### P1.5.4 Red-shift

- a) If a wave source is moving relative to an observer there will be a change in the observed wavelength and frequency. This is known as the Doppler effect.

#### Additional guidance:

The following should be included:

- the wave source could be light, sound or microwaves
- when the source moves away from the observer, the observed wavelength increases and the frequency decreases
- when the source moves towards the observer, the observed wavelength decreases and the frequency increases.

- b) There is an observed increase in the wavelength of light from most distant galaxies. The further away the galaxies are, the faster they are moving, and the bigger the observed increase in wavelength. This effect is called red-shift.
- c) How the observed red-shift provides evidence that the universe is expanding and supports the 'Big Bang' theory (that the universe began from a very small initial point).
- d) Cosmic microwave background radiation (CMBR) is a form of electromagnetic radiation filling the universe. It comes from radiation that was present shortly after the beginning of the universe.
- e) The 'Big Bang' theory is currently the only theory that can explain the existence of CMBR.

#### Suggested ideas for practical work to develop skills and understanding include the following:

- reflecting light off a plane mirror at different angles
- using a class set of skipping ropes to investigate frequency and wavelength
- demonstrating transverse and longitudinal waves with a slinky spring
- carrying out refraction investigations using a glass block
- carrying out investigations using ripple tanks, including the relationship between depth of water and speed of wave
- investigating the range of Bluetooth or infrared communications between mobile phones and laptops
- demonstrating the Doppler effect for sound.



## 3.4 Unit 2: Physics 2

### P2.1 Forces and their effects

Forces can cause changes to the shape or motion of an object. Objects can move in a straight line at a constant speed. They can also change their speed and/or direction (accelerate or decelerate). Graphs can help us to describe the movement of an object. These may be distance-time graphs or velocity-time graphs.

**Candidates should use their skills, knowledge and understanding to:**

- interpret data from tables and graphs relating to speed, velocity and acceleration
- evaluate the effects of alcohol and drugs on stopping distances
- evaluate how the shape and power of a vehicle can be altered to increase the vehicle's top speed
- draw and interpret velocity-time graphs for objects that reach terminal velocity, including a consideration of the forces acting on the object.

#### P2.1.1 Resultant forces

- a) Whenever two objects interact, the forces they exert on each other are equal and opposite.
- b) A number of forces acting at a point may be replaced by a single force that has the same effect on the motion as the original forces all acting together. This single force is called the resultant force.

- c) A resultant force acting on an object may cause a change in its state of rest or motion.

#### Additional guidance:

Candidates should be able to determine the resultant of opposite or parallel forces acting in a straight line.

- d) If the resultant force acting on a stationary object is:

- zero, the object will remain stationary
- not zero, the object will accelerate in the direction of the resultant force.

- e) If the resultant force acting on a moving object is:

- zero, the object will continue to move at the same speed and in the same direction
- not zero, the object will accelerate in the direction of the resultant force.

## P2.1.2 Forces and motion

- a) The acceleration of an object is determined by the resultant force acting on the object and the mass of the object.

$$a = \frac{F}{m} \text{ or } F = m \times a$$

- b) The gradient of a distance–time graph represents speed.

- c) **Calculation of the speed of an object from the gradient of a distance–time graph.**

- d) The velocity of an object is its speed in a given direction.

- e) The acceleration of an object is given by the equation:

$$a = \frac{v - u}{t}$$

- f) The gradient of a velocity–time graph represents acceleration.

- g) **Calculation of the acceleration of an object from the gradient of a velocity–time graph.**

- h) **Calculation of the distance travelled by an object from a velocity–time graph.**

### Additional guidance:

$F$  is the resultant force in newtons, N

$m$  is the mass in kilograms, kg

$a$  is the acceleration in metres per second squared,  $\text{m/s}^2$

Candidates should be able to construct distance–time graphs for an object moving in a straight line when the body is stationary or moving with a constant speed.

**HT only**

### Additional guidance:

$a$  is the acceleration in metres per second squared,  $\text{m/s}^2$

$v$  is the final velocity in metres per second,  $\text{m/s}$

$u$  is the initial velocity in metres per second,  $\text{m/s}$

$t$  is the time taken in seconds, s

### Additional guidance:

**HT only**

**HT only**

## P2.1.3 Forces and braking

- a) When a vehicle travels at a steady speed the resistive forces balance the driving force.

- b) The greater the speed of a vehicle the greater the braking force needed to stop it in a certain distance.

### Additional guidance:

Candidates should realise that most of the resistive forces are caused by air resistance.

Candidates should understand that for a given braking force the greater the speed, the greater the stopping distance.

- c) The stopping distance of a vehicle is the sum of the distance the vehicle travels during the driver's reaction time (thinking distance) and the distance it travels under the braking force (braking distance).

**Additional guidance:**

Candidates should appreciate that distractions may affect a driver's ability to react.

- d) A driver's reaction time can be affected by tiredness, drugs and alcohol.

- e) When the brakes of a vehicle are applied, work done by the friction force between the brakes and the wheel reduces the kinetic energy of the vehicle and the temperature of the brakes increase.

**Additional guidance:**

Candidates should understand that 'adverse road conditions' includes wet or icy conditions. Poor condition of the car is limited to the car's brakes or tyres.

- f) A vehicle's braking distance can be affected by adverse road and weather conditions and poor condition of the vehicle.

### P2.1.4 Forces and terminal velocity

- a) The faster an object moves through a fluid the greater the frictional force that acts on it.

**Additional guidance:**

Candidates should understand why the use of a parachute reduces the parachutist's terminal velocity.

- b) An object falling through a fluid will initially accelerate due to the force of gravity. Eventually the resultant force will be zero and the object will move at its terminal velocity (steady speed).

- c) Draw and interpret velocity-time graphs for objects that reach terminal velocity, including a consideration of the forces acting on the object.

**Additional guidance:**

$W$  is the weight in newtons, N

$m$  is the mass in kilograms, kg

$g$  is the gravitational field strength in newtons per kilogram, N/kg

- d) Calculate the weight of an object using the force exerted on it by a gravitational force:

$$W = m \times g$$

### P2.1.5 Forces and elasticity

- a) A force acting on an object may cause a change in shape of the object.

**Additional guidance:**

Calculation of the energy stored when stretching an elastic material is **not** required.

- b) A force applied to an elastic object such as a spring will result in the object stretching and storing elastic potential energy.

- c) For an object that is able to recover its original shape, elastic potential energy is stored in the object when work is done on the object to change its shape.

- d) The extension of an elastic object is directly proportional to the force applied, provided that the limit of proportionality is not exceeded:

$$F = k \times e$$

**Additional guidance:**

$F$  is the force in newtons, N

$k$  is the spring constant in newtons per metre, N/m

$e$  is the extension in metres, m

**Suggested ideas for practical work to develop skills and understanding include the following:**

- dropping a penny and a feather in a vacuum and through the air to show the effect of air resistance
- plan and carry out an investigation into Hooke's law
- catapult practicals to compare stored energy
- measurement of acceleration of trolleys using known forces and masses
- timing objects falling through a liquid, eg wallpaper paste or glycerine, using light gates or stop clocks
- plan and carry out an investigation to measure the effects of air resistance on parachutes, paper spinners, cones or bun cases
- measuring reaction time with and without distractions, eg iPod off and then on.

## P2.2 The kinetic energy of objects speeding up or slowing down

When an object speeds up or slows down, its kinetic energy increases or decreases. The forces which cause the change in speed do so by doing work. The momentum of an object is the product of the object's mass and velocity.

**Candidates should use their skills, knowledge and understanding to:**

- evaluate the benefits of different types of braking system, such as regenerative braking

**Additional guidance:**

- evaluate the benefits of air bags, crumple zones, seat belts and side impact bars in cars.

This should include ideas of both energy changes and momentum changes.

### P2.2.1 Forces and energy

- a) When a force causes an object to move through a distance work is done.

- b) Work done, force and distance are related by the equation:

$$W = F \times d$$

**Additional guidance:**

$W$  is the work done in joules, J

$F$  is the force applied in newtons, N

$d$  is the distance moved in the direction of the force in metres, m

- c) Energy is transferred when work is done.

**Additional guidance:**

Candidates should be able to discuss the transfer of kinetic energy in particular situations. Examples might include shuttle re-entry or meteorites burning up in the atmosphere.

- d) Work done against frictional forces.

- e) Power is the work done or energy transferred in a given time.

$$P = \frac{E}{t}$$

**Additional guidance:**

$P$  is the power in watts, W

$E$  is the energy transferred in joules, J

$t$  is the time taken in seconds, s

- f) Gravitational potential energy is the energy that an object has by virtue of its position in a gravitational field.

$$E_p = m \times g \times h$$

Candidates should understand that when an object is raised vertically work is done against gravitational force and the object gains gravitational potential energy.

$E_p$  is the change in gravitational potential energy in joules, J

$m$  is the mass in kilograms, kg

$g$  is the gravitational field strength in newtons per kilogram, N/kg

$h$  is the change in height in metres, m

- g) The kinetic energy of an object depends on its mass and its speed.

$$E_k = \frac{1}{2} \times m \times v^2$$

$E_k$  is the kinetic energy in joules, J

$m$  is the mass in kilograms, kg

$v$  is the speed in metres per second, m/s

### P2.2.2 Momentum

- a) Momentum is a property of moving objects.

$$p = m \times v$$

**Additional guidance:**

$p$  is momentum in kilograms metres per second, kg m/s

$m$  is the mass in kilograms, kg

$v$  is the velocity in metres per second, m/s

- b) In a closed system the total momentum before an event is equal to the total momentum after the event. This is called conservation of momentum.

Candidates may be required to complete calculations involving two objects.

Examples of events are collisions and explosions.

**Suggested ideas for practical work to develop skills and understanding include the following:**

- investigating the transfer of  $E_p$  to  $E_k$  by dropping a card through a light gate
- plan and carry out an investigation to measure velocity using trolleys and ramps
- running upstairs and calculating work done and power, lifting weights to measure power
- a motor lifting a load to show how power changes with load
- stretching different materials before using as catapults to show the different amounts of energy transferred, indicated by speed reached by the object or distance travelled.

**P2.3 Currents in electrical circuits**

The current in an electric circuit depends on the resistance of the components and the supply.

**Candidates should use their skills, knowledge and understanding to:**

- apply the principles of basic electrical circuits to practical situations
- evaluate the use of different forms of lighting, in terms of cost and energy efficiency.

**Additional guidance:**

Examples might include filament bulbs, fluorescent bulbs and light-emitting diodes (LEDs).

**P2.3.1 Static electricity**

- a) When certain insulating materials are rubbed against each other they become electrically charged. Negatively charged electrons are rubbed off one material and onto the other.
- b) The material that gains electrons becomes negatively charged. The material that loses electrons is left with an equal positive charge.
- c) When two electrically charged objects are brought together they exert a force on each other.
- d) Two objects that carry the same type of charge repel. Two objects that carry different types of charge attract.
- e) Electrical charges can move easily through some substances, eg metals.

### P2.3.2 Electrical circuits

- a) Electric current is a flow of electric charge.  
The size of the electric current is the rate of flow of electric charge. The size of the current is given by the equation:

$$I = \frac{Q}{t}$$

- b) The potential difference (voltage) between two points in an electric circuit is the work done (energy transferred) per coulomb of charge that passes between the points.

$$V = \frac{W}{Q}$$

- c) Circuit diagrams using standard symbols.  
The following standard symbols should be known:

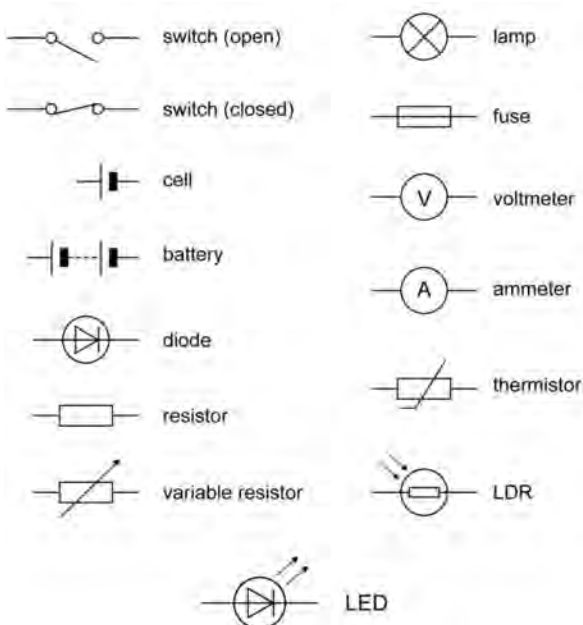

- d) Current–potential difference graphs are used to show how the current through a component varies with the potential difference across it.

#### Additional guidance:

$I$  is the current in amperes (amps), A

$Q$  is the charge in coulombs, C

$t$  is the time in seconds, s

Teachers can use either of the terms potential difference or voltage. Questions will be set using the term potential difference. Candidates will gain credit for the correct use of either term.

$V$  is the potential difference in volts, V

$W$  is the work done in joules, J

$Q$  is the charge in coulombs, C

Candidates will be required to interpret and draw circuit diagrams.

Knowledge and understanding of the use of thermistors in circuits, eg thermostats is required.

Knowledge and understanding of the applications of light-dependent resistors (LDRs) is required, eg switching lights on when it gets dark.



- e) The current–potential difference graphs for a resistor at constant temperature.

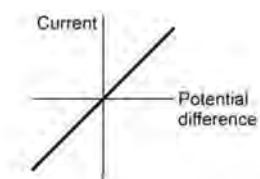

- f) The resistance of a component can be found by measuring the current through, and potential difference across, the component.
- g) The current through a resistor (at a constant temperature) is directly proportional to the potential difference across the resistor.
- h) Calculate current, potential difference or resistance using the equation:

$$V = I \times R$$

**Additional guidance:**

$V$  is the potential difference in volts, V

$I$  is the current in amperes (amps), A

$R$  is the resistance in ohms,  $\Omega$

- i) The current through a component depends on its resistance. The greater the resistance the smaller the current for a given potential difference across the component.
- j) The potential difference provided by cells connected in series is the sum of the potential difference of each cell (depending on the direction in which they are connected).
- k) For components connected in series:
- the total resistance is the sum of the resistance of each component
  - there is the same current through each component
  - the total potential difference of the supply is shared between the components.
- l) For components connected in parallel:
- the potential difference across each component is the same
  - the total current through the whole circuit is the sum of the currents through the separate components.

- m) The resistance of a filament bulb increases as the temperature of the filament increases.

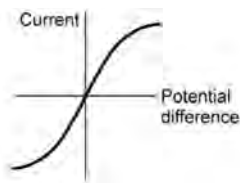

**Additional guidance:**

**HT only**

Candidates should be able to explain resistance change in terms of ions and electrons.

- n) The current through a diode flows in one direction only. The diode has a very high resistance in the reverse direction.

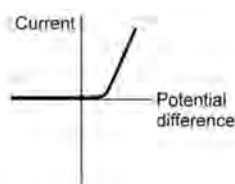

**Additional guidance:**

Candidates should be aware that there is an increasing use of LEDs for lighting, as they use a much smaller current than other forms of lighting.

- o) An LED emits light when a current flows through it in the forward direction.

- p) The resistance of a light-dependent resistor (LDR) decreases as light intensity increases.

**Additional guidance:**

Knowledge of a negative temperature coefficient thermistor only is required.

- q) The resistance of a thermistor decreases as the temperature increases.

**Suggested ideas for practical work to develop skills and understanding include the following:**

- using filament bulbs and resistors to investigate potential difference/current characteristics
- investigating potential difference/current characteristics for LDRs and thermistors
- setting up series and parallel circuits to investigate current and potential difference
- plan and carry out an investigation to find the relationship between the resistance of thermistors and their temperature
- investigating the change of resistance of LDRs with light intensity.

## P2.4 Using mains electricity safely and the power of electrical appliances

Mains electricity is useful but can be very dangerous. It is important to know how to use it safely.

Electrical appliances transfer energy. The power of an electrical appliance is the rate at which it transforms energy. Most appliances have their power and the potential difference of the supply they need printed on them. From this we can calculate their current and the fuse they need.

### Candidates should use their skills, knowledge and understanding to:

- understand the principles of safe practice and recognise dangerous practice in the use of mains electricity
- compare the uses of fuses and circuit breakers
- evaluate and explain the need to use different cables for different appliances
- consider the factors involved when making a choice of electrical appliances.

#### Additional guidance:

Candidates should consider the efficiency and power of the appliance.

### P2.4.1 Household electricity

a) Cells and batteries supply current that always passes in the same direction. This is called direct current (d.c.).

b) An alternating current (a.c.) is one that is constantly changing direction.

#### Additional guidance:

Candidates should be able to compare and calculate potential differences of d.c. supplies and the peak potential differences of a.c. supplies from diagrams of oscilloscope traces.

**Higher Tier candidates should be able to determine the period and hence the frequency of a supply from diagrams of oscilloscope traces.**

c) Mains electricity is an a.c. supply. In the UK it has a frequency of 50 cycles per second (50 hertz) and is about 230 V.

d) Most electrical appliances are connected to the mains using cable and a three-pin plug.

#### Additional guidance:

Candidates should be familiar with both two-core and three-core cable.

e) The structure of electrical cable.

f) The structure and wiring of a three-pin plug.

Knowledge and understanding of the materials used in three-pin plugs is required, as is the colour coding of the covering of the three wires.

g) If an electrical fault causes too great a current, the circuit is disconnected by a fuse or a circuit breaker in the live wire.

h) When the current in a fuse wire exceeds the rating of the fuse it will melt, breaking the circuit.

i) Some circuits are protected by Residual Current Circuit Breakers (RCCBs).

j) Appliances with metal cases are usually earthed.

k) The earth wire and fuse together protect the wiring of the circuit.

**Additional guidance:**

Candidates should realise that RCCBs operate by detecting a difference in the current between the live and neutral wires. Knowledge of how the devices do this is **not** required.

Candidates should be aware of the fact that this device operates much faster than a fuse.

Candidates should be aware that some appliances are double insulated, and therefore have no earth wire connection.

Candidates should have an understanding of the link between cable thickness and fuse value.

**P2.4.2 Current, charge and power**

a) When an electrical charge flows through a resistor, the resistor gets hot.

b) The rate at which energy is transferred by an appliance is called the power.

$$P = \frac{E}{t}$$

c) Power, potential difference and current are related by the equation:

$$P = I \times V$$

**Additional guidance:**

Candidates should understand that a lot of energy is wasted in filament bulbs by heating. Less energy is wasted in power saving lamps such as Compact Fluorescent Lamps (CFLs).

Candidates should understand that there is a choice when buying new appliances in how efficiently they transfer energy.

$P$  is power in watts, W

$E$  is energy in joules, J

$t$  is time in seconds, s

Candidates should be able to calculate the current through an appliance from its power and the potential difference of the supply, and from this determine the size of fuse needed.

$P$  is power in watts, W

$I$  is current in amperes (amps), A

$V$  is potential difference in volts, V

d) **Energy transferred, potential difference and charge are related by the equation:**

$$E = V \times Q$$

**Additional guidance:**

**HT only**

**$E$  is energy in joules, J**

**$V$  is potential difference in volts, V**

**$Q$  is charge in coulombs, C**

**Suggested ideas for practical work to develop skills and understanding include the following:**

- measuring oscilloscope traces
- demonstrating the action of fuse wires
- using fluctuations in light intensity measurements from filament bulbs to determine the frequency of a.c.
- measuring the power of 12 V appliances by measuring energy transferred (using a joulemeter or ammeter and voltmeter) in a set time.

**P2.5 What happens when radioactive substances decay, and the uses and dangers of their emissions**

Radioactive substances emit radiation from the nuclei of their atoms all the time. These nuclear radiations can be very useful but may also be very dangerous. It is important to understand the properties of different types of nuclear radiation. To understand what happens to radioactive substances when they decay we need to understand the structure of the atoms from which they are made. The use of radioactive sources depends on their penetrating power and half-life.

**Candidates should use their skills, knowledge and understanding to:**

- evaluate the effect of occupation and/or location on the level of background radiation and radiation dose
- evaluate the possible hazards associated with the use of different types of nuclear radiation
- evaluate measures that can be taken to reduce exposure to nuclear radiations
- evaluate the appropriateness of radioactive sources for particular uses, including as tracers, in terms of the type(s) of radiation emitted and their half-lives
- explain how results from the Rutherford and Marsden scattering experiments led to the 'plum pudding' model being replaced by the nuclear model.

**Additional guidance:**

Candidates should realise that new evidence can cause a theory to be re-evaluated.

Candidates should realise that, according to the nuclear model, most of the atom is empty space.

### P2.5.1 Atomic structure

- a) The basic structure of an atom is a small central nucleus composed of protons and neutrons surrounded by electrons.
- b) The relative masses and relative electric charges of protons, neutrons and electrons.
- c) In an atom the number of electrons is equal to the number of protons in the nucleus. The atom has no overall electrical charge.
- d) Atoms may lose or gain electrons to form charged particles called ions.
- e) The atoms of an element always have the same number of protons, but have a different number of neutrons for each isotope. The total number of protons in an atom is called its atomic number. The total number of protons and neutrons in an atom is called its mass number.

#### Additional guidance:

Candidates should appreciate the relative size of the nucleus compared to the size of the atom.

### P2.5.2 Atoms and radiation

- a) Some substances give out radiation from the nuclei of their atoms all the time, whatever is done to them. These substances are said to be radioactive.
- b) The origins of background radiation.
- c) Identification of an alpha particle as two neutrons and two protons, the same as a helium nucleus, a beta particle as an electron from the nucleus and gamma radiation as electromagnetic radiation.

#### Additional guidance:

Candidates should be aware of the random nature of radioactive decay.

Knowledge and understanding should include both natural sources, such as rocks and cosmic rays from space, and man-made sources such as the fallout from nuclear weapons tests and nuclear accidents.

- d) **Nuclear equations to show single alpha and beta decay.**

#### Additional guidance:

**HT only**

**Candidates will be required to balance such equations, limited to the completion of atomic number and mass number. The identification of daughter elements from such decays is not required.**

- e) Properties of the alpha, beta and gamma radiations limited to their relative ionising power, their penetration through materials and their range in air.

- f) Alpha and beta radiations are deflected by both electric and magnetic fields but gamma radiation is not.

**Additional guidance:**

All candidates should know that alpha particles are deflected less than beta particles and in an opposite direction.

**Higher Tier candidates should be able to explain this in terms of the relative mass and charge of each particle.**

- g) The uses of and the dangers associated with each type of nuclear radiation.

- h) The half-life of a radioactive isotope is the average time it takes for the number of nuclei of the isotope in a sample to halve, or the time it takes for the count rate from a sample containing the isotope to fall to half its initial level.

**Suggested ideas for practical work to develop skills and understanding include the following:**

- using hot-cross buns to show the 'plum pudding' model
- using dice to demonstrate probabilities involved in half-life
- using Geiger counters to measure the penetration and range in air of the radiation from different sources.

## P2.6 Nuclear fission and nuclear fusion

During the process of nuclear fission atomic nuclei split. This process releases energy, which can be used to heat water and turn it into steam. The steam drives a turbine, which is connected to a generator and generates electricity.

Nuclear fusion is the joining together of atomic nuclei and is the process by which energy is released in stars.

**Candidates should use their skills, knowledge and understanding to:**

- compare the uses of nuclear fusion and nuclear fission.

**Additional guidance:**

Limited to the generation of electricity.

### P2.6.1 Nuclear fission

- a) There are two fissionable substances in common use in nuclear reactors: uranium-235 and plutonium-239.
- b) Nuclear fission is the splitting of an atomic nucleus.
- c) For fission to occur the uranium-235 or plutonium-239 nucleus must first absorb a neutron.

**Additional guidance:**

The majority of nuclear reactors use uranium-235.

- d) The nucleus undergoing fission splits into two smaller nuclei and two or three neutrons and energy is released.

- e) The neutrons may go on to start a chain reaction.

**Additional guidance:**

Candidates should be able to sketch or complete a labelled diagram to illustrate how a chain reaction may occur.

**P2.6.2 Nuclear fusion**

- a) Nuclear fusion is the joining of two atomic nuclei to form a larger one.

- b) Nuclear fusion is the process by which energy is released in stars.

- c) Stars form when enough dust and gas from space is pulled together by gravitational attraction. Smaller masses may also form and be attracted by a larger mass to become planets.

- d) During the 'main sequence' period of its life cycle a star is stable because the forces within it are balanced.

- e) A star goes through a life cycle. This life cycle is determined by the size of the star.

**Additional guidance:**

Candidates should be able to explain why the early Universe contained only hydrogen but now contains a large variety of different elements.

The term 'radiation pressure' will **not** be required.

Candidates should be familiar with the chart on the next page that shows the life cycles of stars.



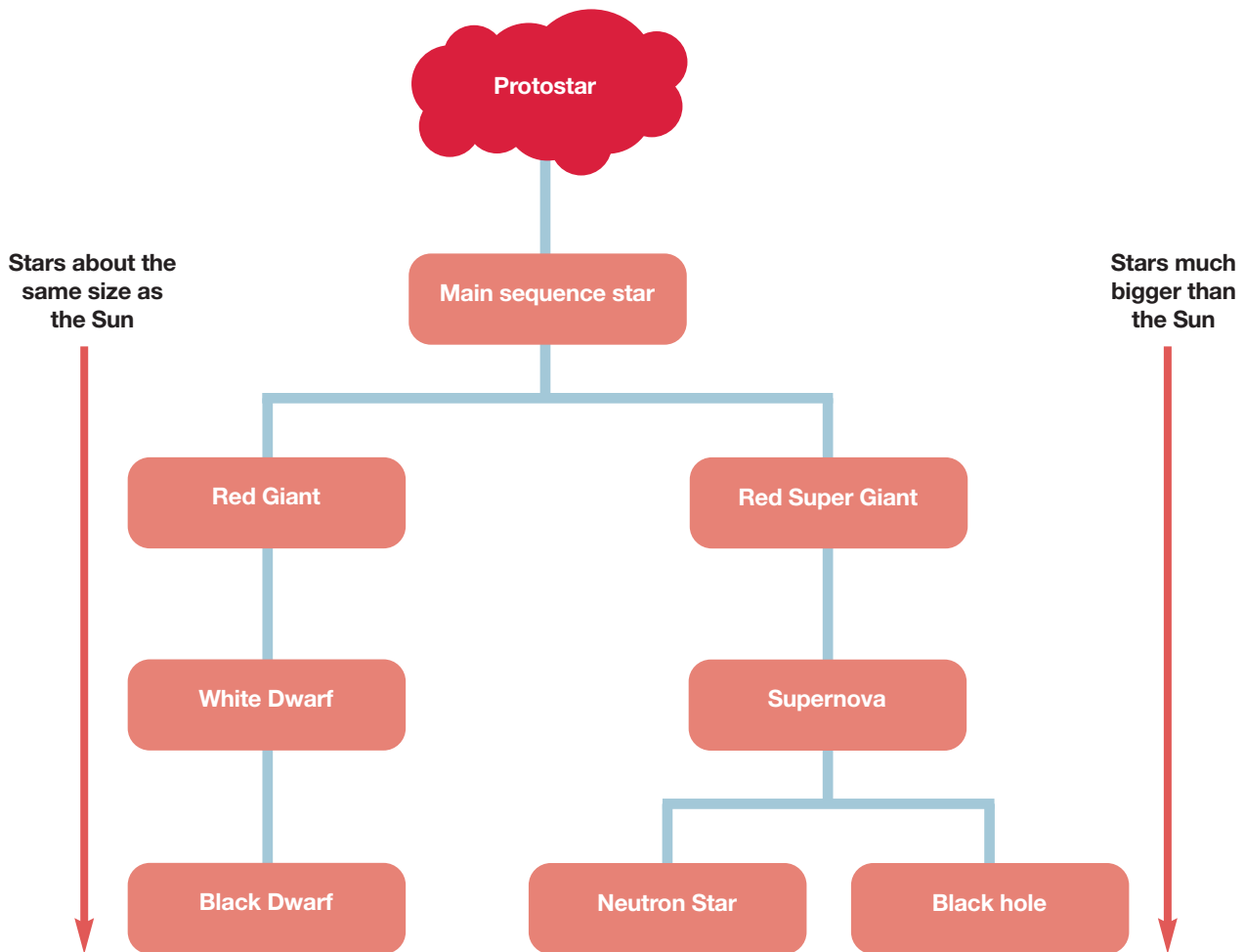

- f) Fusion processes in stars produce all of the naturally occurring elements. These elements may be distributed throughout the Universe by the explosion of a massive star (supernova) at the end of its life.

**Additional guidance:**

Candidates should be able to explain how stars are able to maintain their energy output for millions of years.

Candidates should know that elements up to iron are formed during the stable period of a star. Elements heavier than iron are formed in a supernova.

**Suggested ideas for practical work to develop skills and understanding include the following:**

- using domino tracks for fission/chain reactions.

## 3.5 Unit 3: Physics 3

### P3.1 Medical applications of physics

Physics has many applications in the field of medicine. These include the uses of X-rays and ultrasound for scanning, and of light for image formation with lenses and endoscopes

#### Candidates should use their skills, knowledge and understanding to:

- draw and interpret ray diagrams in order to determine the nature of the image

#### Additional guidance:

In ray diagrams a convex lens will be represented by:



A concave lens will be represented by:



- evaluate the use of different lenses for the correction of defects of vision

- compare the medical use of ultrasound and X rays

#### Additional guidance:

Candidates should understand that some of the differences in use are because ultrasound waves are non-ionising and X rays are ionising.

- evaluate the advantages and disadvantages of using ultrasound, X-rays and Computerised Tomography (CT) scans.

Limited to safety issues and the quality of image formed.

#### P3.1.1 X-rays

- a) X-rays are part of the electromagnetic spectrum. They have a very short wavelength and cause ionisation.

#### Additional guidance:

Properties of X-rays include:

- they affect a photographic film in the same way as light
- they are absorbed by metal and bone
- they are transmitted by soft tissue
- their wavelength is of the same order of magnitude as the diameter of an atom.

- b) X-rays can be used to diagnose and treat some medical conditions.

Examples include CT scans, bone fractures, dental problems and killing cancer cells.

The use of charge-coupled devices (CCDs) allows images to be formed electronically.

- c) Precautions to be taken when X-ray machines and CT scanners are in use.

### P3.1.2 Ultrasound

- a) Electronic systems can be used to produce ultrasound waves, which have a frequency higher than the upper limit of hearing for humans.
- b) Ultrasound waves are partially reflected when they meet a boundary between two different media. The time taken for the reflections to reach a detector can be used to determine how far away such a boundary is.

#### Additional guidance:

Candidates should know that the range of human hearing is about 20 Hz to 20 000 Hz.

- c) Calculation of the distance between interfaces in various media.

$$s = v \times t$$

#### Additional guidance:

Candidates may be required to use data from diagrams of oscilloscope traces.

$s$  is distance in metres, m

$v$  is speed in metres per second, m/s

$t$  is time in seconds, s

- d) Ultrasound waves can be used in medicine.

Examples include pre-natal scanning and the removal of kidney stones.

### P3.1.3 Lenses

- a) Refraction is the change of direction of light as it passes from one medium to another.
- b) A lens forms an image by refracting light.
- c) In a convex or converging lens, parallel rays of light are brought to a focus at the principal focus. The distance from the lens to the principal focus is called the focal length.

$$\text{refractive index} = \frac{\sin i}{\sin r}$$

#### Additional guidance:

$i$  is the angle of incidence

$r$  is the angle of refraction

- d) The nature of an image is defined by its size relative to the object, whether it is upright or inverted relative to the object and whether it is real or virtual.
- e) The nature of the image produced by a converging lens for an object placed at different distances from the lens.
- f) The use of a converging lens as a magnifying glass.
- g) The nature of the image produced by a concave or diverging lens.

- h) The construction of ray diagrams to show the formation of images by converging and diverging lenses.

**Additional guidance:**

Candidates may be asked to complete ray diagrams drawn on graph paper.

- i) The magnification produced by a lens is calculated using the equation:

$$\text{magnification} = \frac{\text{image height}}{\text{object height}}$$

**P3.1.4 The eye**

- a) The structure of the eye.

The structure of the eye is limited to:

- retina
- lens
- cornea
- pupil/iris
- ciliary muscle
- suspensory ligaments.

**Additional guidance:**

Candidates should know the function of these named parts.

Candidates should understand how the action of the ciliary muscle causes changes in the shape of the lens, which allows the light to be focused at varying distances.

- b) Correction of vision using convex and concave lenses to produce an image on the retina:

- long sight, caused by the eyeball being too short, or the eye lens being unable to focus
- short sight, caused by the eyeball being too long, or the eye lens being unable to focus.

**Additional guidance:**

Candidates should know that the near point is approximately 25 cm and the far point is infinity.

- c) Range of vision. The eye can focus on objects between the near point and the far point.

- d) Comparison between the structure of the eye and the camera.

Candidates should be aware that the film in a camera or the CCDs in a digital camera is the equivalent of the retina in the eye.

- e) The power of a lens is given by:

$$P = \frac{1}{f}$$

Candidates should know that the power of a converging lens is positive and the power of a diverging lens is negative.

$P$  is power in dioptres, D

$f$  is focal length in metres, m

- f) The focal length of a lens is determined by:
- the refractive index of the material from which the lens is made, and
  - the curvature of the two surfaces of the lens.

- g) **For a given focal length, the greater the refractive index, the flatter the lens. This means that the lens can be manufactured thinner.**

**Additional guidance:**

**HT only**

**P3.1.5 Other applications using light**

- a) Total internal reflection and critical angle.

$$\text{refractive index} = \frac{1}{\sin c}$$

- b) Visible light can be sent along optical fibres.

- c) The laser as an energy source for cutting, cauterising and burning.

**Additional guidance:**

Candidates need to understand the concept of critical angle but knowledge of the values of critical angles is not required.

**HT only**

**c is the critical angle**

Examples of use should include the endoscope for internal imaging.

Knowledge of how lasers work is **not** required. Applications should include use in eye surgery.

**Suggested ideas for practical work to develop skills and understanding include the following:**

- demonstrating the range of frequencies audible to the human ear, using a signal generator, loudspeaker and oscilloscope
- demonstrating long and short sight by placing a screen, not at the focal point, and rectifying the image through the use of appropriate lenses
- using a round bottom flask filled with a solution of fluorescein to represent the eye
- investigating total internal reflection using a semi-circular glass block.

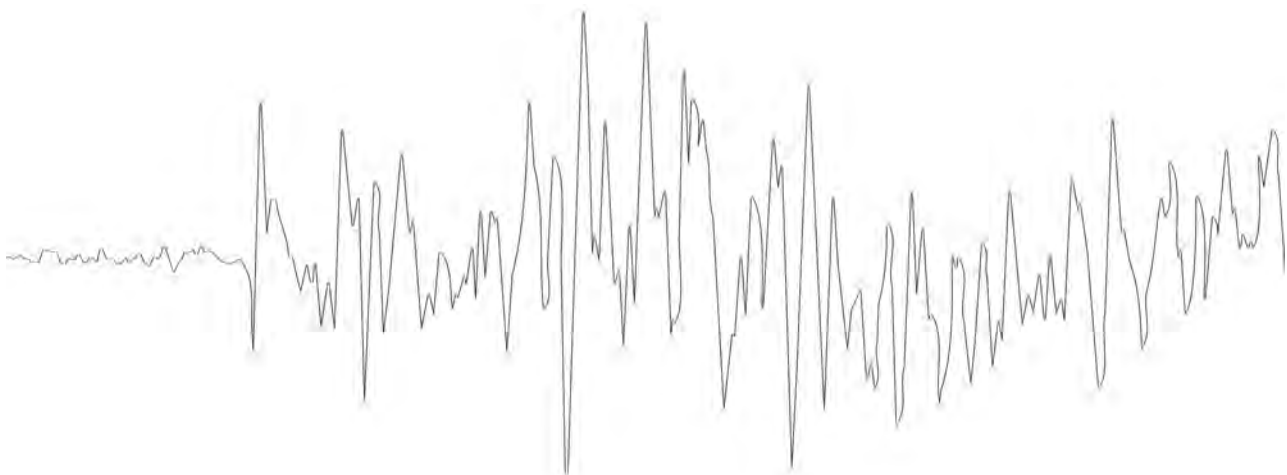

## P3.2 Using physics to make things work

Many things, from simple toys to complex fairground rides, are constructed from basic machines such as the lever. A knowledge of the physics involved in balancing and turning can help us to make these appliances work.

### Candidates should use their skills, knowledge and understanding to:

- analyse the stability of objects by evaluating their tendency to topple
- recognise the factors that affect the stability of an object
- evaluate how the design of objects affects their stability

#### Additional guidance:

Candidates should use a range of laboratory equipment to model real-life situations, eg cranes.

Candidates should recognise that objects with a wide base and low centre of mass are more stable than those with a narrow base and a high centre of mass.

- interpret and evaluate data on objects moving in circular paths.

#### Additional guidance:

Candidates should understand that a centripetal force does not exist in its own right but is always provided by something else such as gravitational force, friction or tension.

### P3.2.1 Centre of mass

- a) The centre of mass of an object is that point at which the mass of the object may be thought to be concentrated.
- b) If freely suspended, an object will come to rest with its centre of mass directly below the point of suspension.
- c) The centre of mass of a symmetrical object is along the axis of symmetry.

#### Additional guidance:

Candidates will be expected to be able to describe how to find the centre of mass of a thin, irregular sheet of a material.

- d) For a simple pendulum:

$$T = \frac{1}{f}$$

- e) The time period depends on the length of a pendulum.

#### Additional guidance:

$T$  is periodic time in seconds, s

$f$  is frequency in hertz, Hz

The equation  $T = 2\pi\sqrt{l/g}$  is **not** required.

Applications of the pendulum should include simple fairground and playground rides.

### P3.2.2 Moments

a) The turning effect of a force is called the moment.

b) The size of the moment is given by the equation:

$$M = F \times d$$

#### Additional guidance:

$M$  is the moment of the force in newton-metres, Nm

$F$  is the force in newtons, N

$d$  is the perpendicular distance from the line of action of the force to the pivot in metres, m

c) If an object is not turning, the total clockwise moment must be exactly balanced by the total anticlockwise moment about any pivot.

d) **The calculation of the size of a force, or its distance from pivot, acting on an object that is balanced.**

#### Additional guidance:

HT only

e) Ideas of simple levers.

Limited to levers as force multipliers.

f) **If the line of action of the weight of an object lies outside the base of the object there will be a resultant moment and the body will tend to topple.**

HT only

Applications should include vehicles and simple balancing toys.

### P3.2.3 Hydraulics

a) Liquids are virtually incompressible, and the pressure in a liquid is transmitted equally in all directions.

#### Additional guidance:

Candidates should understand that this means that a force exerted at one point on a liquid will be transmitted to other points in the liquid.

b) The use of different cross-sectional areas on the effort and load side of a hydraulic system enables the system to be used as a force multiplier.

c) The pressure in different parts of a hydraulic system is given by:

$$P = \frac{F}{A}$$

#### Additional guidance:

$P$  is the pressure in pascals, Pa

$F$  is the force in newtons, N

$A$  is the cross-sectional area in metres squared, m<sup>2</sup>



### P3.2.4 Circular motion

- a) When an object moves in a circle it continuously accelerates towards the centre of the circle. This acceleration changes the direction of motion of the body, not its speed.

- b) The resultant force causing this acceleration is called the centripetal force and is always directed towards the centre of the circle.

- c) The centripetal force needed to make an object perform circular motion increases as:

- the mass of the object increases
- the speed of the object increases
- the radius of the circle decreases.

#### Additional guidance:

Candidates should be able to identify which force(s) provide(s) the centripetal force in a given situation.

The equation

$$F = \frac{mv^2}{r}$$

is **not** required.

#### Suggested ideas for practical work to develop skills and understanding include the following:

- demonstrating that pressure in liquids acts in all directions using a circular container with holes around it
- finding the centre of mass of an irregularly shaped card
- using a balanced metre ruler and masses to verify the principle of moments
- plan and carry out an investigation into factors that affect the period of a simple pendulum (mass, length of pendulum, amplitude of swing)
- whirling a bung on the end of a piece of string to demonstrate the factors that affect centripetal force
- investigating objects and slopes to find out the point at which the object topples.

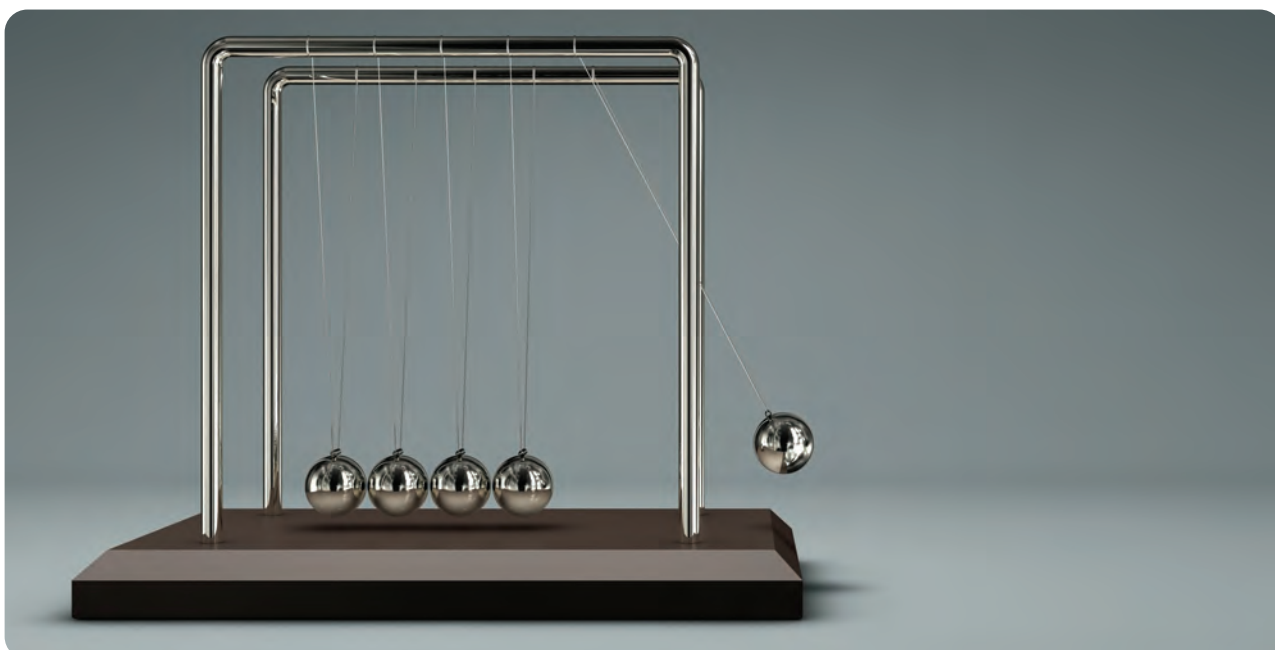

### P3.3 Keeping things moving

Electric currents produce magnetic fields. Forces produced in magnetic fields can be used to make things move. This is called the motor effect and is how appliances such as the electric motor create movement.

Many appliances do not use 230 volts mains electricity. Transformers are used to provide the required potential difference.

#### Candidates should use their skills, knowledge and understanding to:

- interpret diagrams of electromagnetic appliances in order to explain how they work

- compare the use of different types of transformer for a particular application.

#### Additional guidance:

Examples might include some mobile phone chargers and power supplies for lap top computers.

#### P3.3.1 The motor effect

- a) When a current flows through a wire a magnetic field is produced around the wire.

- b) The motor effect and its use.

- c) The size of the force can be increased by:

- increasing the strength of the magnetic field
- increasing the size of the current.

- d) The conductor will not experience a force if it is parallel to the magnetic field.

- e) The direction of the force is reversed if either the direction of the current or the direction of the magnetic field is reversed.

#### Additional guidance:

Applications of electromagnets could include their use on cranes for lifting iron/steel.

Candidates should be able to apply the principles of the motor effect in any given situation.

The equation  $F = BIL$  is **not** required.

#### Additional guidance:

Candidates will be expected to identify the direction of the force using Fleming's left-hand rule.

#### P3.3.2 Transformers

- a) If an electrical conductor 'cuts' through a magnetic field a potential difference is induced across the ends of the conductor.

- b) If a magnet is moved into a coil of wire a potential difference is induced across the ends of the coil.

- c) The basic structure of the transformer.

- d) An alternating current in the primary coil produces a changing magnetic field in the iron core and hence in the secondary coil. This induces an alternating potential difference across the ends of the secondary coil.

**Additional guidance:**

Knowledge of laminations and eddy currents in the core are **not** required.

- e) In a step-up transformer the potential difference across the secondary coil is greater than the potential difference across the primary coil.
- f) In a step-down transformer the potential difference across the secondary coil is less than the potential difference across the primary coil.

- g) The potential difference across the primary and secondary coils of a transformer are related by the equation:

$$\frac{V_p}{V_s} = \frac{n_p}{n_s}$$

- h) If transformers are assumed to be 100% efficient, the electrical power output would equal the electrical power input.

$$V_p \times I_p = V_s \times I_s$$

- i) Switch mode transformers operate at a high frequency, often between 50 kHz and 200 kHz.

- j) Switch mode transformers are much lighter and smaller than traditional transformers working from a 50 Hz mains supply.

- k) Switch mode transformers use very little power when they are switched on but no load is applied.

**Additional guidance:**

$V_p$  is the potential difference across the primary coil in volts, V

$V_s$  is the potential difference across the secondary coil in volts, V

$n_p$  is the number of turns on the primary coil

$n_s$  is the number of turns on the secondary coil

Candidates should be aware that the input to a transformer is determined by the required output.

$V_p$  is the potential difference across the primary coil in volts, V

$I_p$  is the current in the primary coil in amperes (amps), A

$V_s$  is the potential difference across the secondary coil in volts, V

$I_s$  is the current in the secondary coil in amperes (amps), A

**Additional guidance:**

Candidates should be aware that this makes them useful for applications such as mobile phone chargers.

**Suggested ideas for practical work to develop skills and understanding include the following:**

- placing a foil strip with a current going through it in a strong magnetic field
- building a motor
- making a loudspeaker
- making a transformer using C cores and insulated wire
- demonstrating a transformer to show the difference between using d.c. and a.c.

## 3.6 Unit 4: Controlled Assessment

### 3.6.1 Introduction

This unit is assessed by Controlled Assessment. It is worth 25% of the total marks and consists of a minimum of **one** practical investigation based on topics in the specification.

Access arrangements (see sections 4.5 and 5.4) can enable candidates with special needs to undertake this assessment.

Teachers are encouraged to undertake a wide range of practical and investigative work, including fieldwork, with their candidates. We take the view that it is not good practice to do practical work only for the Controlled Assessment. As teachers know well, candidates enjoy and are motivated by practical work. Throughout this specification we have given many examples of practical work supporting the science content. Full details of this practical work are included in our resources package.

In this unit, candidates use a range of practical skills and knowledge in **one** investigation chosen from those supplied by AQA. The investigations are based on topics in the specification. Guidance for teachers will be given with each investigation. Every year, three Controlled Assessments will be available; one for Unit 2 and two for Unit 3. Each task assesses How Science Works skills, not candidates' knowledge and understanding of the science context.

The right-hand column of the tables below shows the Assessment Focus thread from APP (Assessing Pupils' Progress). This will enable teachers to ensure progression from KS3 to KS4.

## P4.1 Plan practical ways to develop and test candidate's own scientific ideas

### Candidates should be able to:

#### P4.1.1 develop hypotheses and plan practical ways to test them, by:

a) being able to develop a hypothesis

#### Additional guidance:

#### AF/thread

Candidates should be able to suggest the outcome of an investigation.

1/4

b) being able to test hypotheses

Candidates should be able to plan a fair test to investigate their hypothesis.

1/4

c) using appropriate technology.

Candidates should appreciate that technology such as data logging may provide a better means of obtaining data. They should be able to suggest appropriate technology for collecting data and explain why a particular technological method is the most appropriate. Candidates should use ICT whenever appropriate.

4/1

## P4.2 Assess and manage risks when carrying out practical work

### Candidates should be able to:

#### P4.2.1 assess and manage risks when carrying out practical work, by:

a) identifying some possible hazards in practical situations

#### Additional guidance:

#### AF/thread

Candidates will be expected to independently recognise a range of familiar hazards and consult appropriate resources and expert advice.

4/4

b) suggesting ways of managing risks.

Candidates should assess risks to themselves and others and take action to reduce these risks by adapting their approaches to practical work in order to control risk.

4/4

## P4.3 Collect primary and secondary data

### Candidates should be able to:

#### P4.3.1 make observations, by:

a) carrying out practical work and research, and using the data collected to develop hypotheses.

#### AF/thread

4/3

**P4.3.2 demonstrate an understanding of the need to acquire high-quality data, by:**

a) appreciating that, unless certain variables are controlled, the results may not be valid

Additional guidance:	AF/thread
Candidates should be able to explain whether results can be considered valid and recognise when an instrument or technique might not be measuring the variable intended.	<b>4/3</b>
Candidates should recognise that a second set of readings with another instrument or by a different observer could be used to cross check results.	<b>4/3</b>
Candidates should understand that accuracy is a measure of how close the measured value is to the true value.	<b>4/3</b>
Candidates should be able to explain that resolution is the smallest change in the quantity being measured (input) of a measuring instrument that gives a perceptible change in the indication (output).	<b>4/3</b>
Candidates should be able to distinguish between accuracy and precision when applied to an instrument's readings.	<b>4/3</b>
Candidates should be able to identify the upper and lower limits of the range and be able to identify which extra results, within or outside the range would be appropriate.	<b>4/3</b>

b) identifying when repeats are needed in order to improve reproducibility

c) recognising the value of further readings to establish repeatability and accuracy

d) considering the resolution of the measuring device

e) considering the precision of the measured data where precision is indicated by the degree of scatter from the mean

f) identifying the range of the measured data.

**P4.4 Select and process primary and secondary data**
**Candidates should be able to:**
**P4.4.1 show an understanding of the value of means, by:**

a) appreciating when it is appropriate to calculate a mean

Additional guidance:	AF/thread
	<b>5/1</b>
Candidates should be able to recognise the need to exclude anomalies before calculating means to an appropriate number of decimal places.	<b>5/1</b>

b) calculating the mean of a set of at least three results.

**P4.4.2 demonstrate an understanding of how data may be displayed, by:**

a) drawing tables

Additional guidance:	AF/thread
Candidates should be able to draw up a table of two or more columns, with correct headings and units, adequately representing the data obtained.	<b>3/2</b>
Candidates should be able to construct an appropriate graphical representation of the data such as a bar chart or line graph and draw a line of best fit when appropriate. Candidates may use ICT to produce their graphs or charts.	<b>3/2</b>
Candidates should be able to identify the most appropriate method of display for any given set of data.	<b>3/1</b>

b) drawing charts and graphs

c) choosing the most appropriate form of presentation.

## P4.5 Analyse and interpret primary and secondary data

Candidates should be able to:

### P4.5.1 distinguish between a fact and an opinion, by:

- a) recognising that an opinion might be influenced by factors other than scientific fact
- b) identifying scientific evidence that supports an opinion.

**Additional guidance:**

**AF/thread**

Candidates should recognise that the opinion may be influenced by economic, ethical, moral, social or cultural considerations.

**2/1**

**1/2**

### P4.5.2 review methodology to assess fitness for purpose, by:

- a) identifying causes of variation in data
- b) recognising and identifying the cause of random errors. If a data set contains random errors, repeating the readings and calculating a new mean can reduce their effect
- c) recognising and identifying the cause of anomalous results
- d) recognising and identifying the cause of systematic errors.

**Additional guidance:**

**AF/thread**

Candidates should be able to identify from data whether there is any variation other than obvious anomalies, and identify a potential cause for variation or uncertainty.

**5/2**

Candidates should appreciate that human error might be the cause of inaccurate measurements and explain how human error might have influenced the accuracy of a measurement or might have introduced bias into a set of readings.

**5/2**

Candidates should be able to identify anomalous results and suggest what should be done about them.

**5/2**

Candidates should be able to identify when a data set contains a systematic error and appreciate that repeat readings cannot reduce the effect of systematic errors.

**5/2**

Candidates should realise that a zero error is a type of systematic error. Candidates should be able to identify if a scale has been incorrectly used and suggest how to compensate for a zero error.

**5/2**

### P4.5.3 identify patterns in data, by:

- a) describing the relationship between two variables and deciding whether the relationship is causal or by association.

**Additional guidance:**

**AF/thread**

Candidates should be able to use terms such as linear or directly proportional, or describe a complex relationship.

**5/3**



**P4.5.4 draw conclusions using scientific ideas and evidence, by:**

- a) writing a conclusion, based on evidence that relates correctly to known facts
- b) using secondary sources
- c) identifying extra evidence that is required for a conclusion to be made
- d) evaluating methods of data collection.

Additional guidance:	AF/thread
Candidates should be able to state simply what the evidence shows to justify a conclusion, and recognise the limitations of evidence.	5/3
Candidates should appreciate that secondary sources or alternative methods can confirm reproducibility.	5/3
Candidates should be able to suggest that extra evidence might be required for a conclusion to be made, and be able to describe the extra evidence required.	5/4
Candidates should appreciate that the evidence obtained may not allow the conclusion to be made with confidence. Candidates should be able to explain why the evidence obtained does not allow the conclusion to be made with confidence.	5/4

**P4.6 Use of scientific models and evidence to develop hypotheses, arguments and explanations**

**Candidates should be able to:**

**P4.6.1 review hypotheses in the light of outcomes, by:**

- a) considering whether or not any hypothesis made is supported by the evidence
- b) developing scientific ideas as a result of observations and measurements.

Additional guidance:	AF/thread
Candidates should be able to assess the extent to which the hypothesis is supported by the outcome.	1/2
Candidates should be able to suggest ways in which the hypothesis may need to be amended, or whether it needs to be discarded in the light of the achieved outcome of an investigation.	1/2

## Guidance on Managing Controlled Assessment

### What is Controlled Assessment?

For each subject, Controlled Assessment regulations from Ofqual stipulate the level of control required for task setting, task taking and task marking. The 'task' is what the candidate has to do; the 'level of control' indicates the degree of freedom given to teachers and candidates for different aspects of the 'task'.

#### For GCSE Physics, the regulations state:

#### For this specification, this means:

Task setting – high control

- We prepare equivalent Investigative Skills Assignments (ISAs) each year.

Task taking  
(research/data collection) – limited control

- We require the practical work and data collection to be carried out under teacher supervision, during normal class contact time.
- If more than one lesson is used, candidates' data and research work must be collected at the end of each lesson.
- Candidates can work together during the investigation, but each candidate must contribute to the collection of the data and process the data individually.

Task taking  
(analysis and evaluation of findings) – high control

- ISA tests should be taken under formal supervision, in silence, without co-operation between candidates.
- Candidates should be given their processed data for reference during the ISA test, and will also be provided with a sheet of secondary data.
- Teachers should not help candidates answer the questions.
- Each ISA has a fixed time limit unless the candidate is entitled to access arrangements.
- Candidates' processed data and their ISA tests are collected by the teacher at the end of each test.

Task marking – medium control

- We provide 'marking guidelines' for each ISA test.
- We moderate your marking.

### What is the Controlled Assessment like?

The Controlled Assessment comprises an ISA test which is assessed in two sections.

Prior to taking Section 1 of the ISA test, candidates independently develop their own hypothesis and research possible methods for carrying out an experiment to test **their** hypothesis. During this research, candidates need to do a risk assessment and prepare a table for their results.

**Section 1** of the ISA test (45 minutes, 20 marks) consists of questions relating to the candidate's own research.

Following Section 1 candidates should carry out their investigation and record and analyse their results. If the candidate's plan is unworkable, unsafe or unmanageable in the laboratory then they may be provided with a method – an example of which will be provided by AQA. For plans that are otherwise good, but unworkable for a good reason (ie logistical) candidates should not lose any marks. However, where the plan is dangerous or unworkable (from a scientific perspective) this will be reflected in the marking.

**Section 2** of the ISA test (50 minutes, 30 marks) consists of questions related to the experiment candidates have carried out. They are also provided with a data sheet of secondary data by AQA, from which they select appropriate data to analyse and compare with their own results.

Candidates will be asked to suggest how ideas from their investigation and research could be used within a new context.

### Using ISAs

The documents provided by AQA for each ISA are:

- a set of Teachers' Notes
- the ISA – Section 1 and Section 2 which are to be copied for each candidate
- the marking guidelines for the teacher to use.

The Teachers' Notes provide suggestions on how to incorporate ISAs into the scheme of work. About five lessons should be allowed for the ISA: one lesson for discussion, research and planning; one lesson for the completion of Section 1; one or two lessons for completing the experiment and processing their results and one lesson for completing Section 2 of the ISA.

Candidates will be expected to plan their investigation independently and should each draw up an appropriate table for recording their results.

While carrying out the investigation, candidates should make and record observations. They should make measurements with precision and accuracy. They should record data as it is obtained in a table. They should use ICT where appropriate. Candidates are also required to process the data into a graph or chart.

Candidates' tables of data and graphs or charts must be collected by the teacher at the end of each lesson. Candidates must **not** be allowed to work on the presentation or processing of their data between lessons, because marks are available for these skills.

The paper containing Section 2 of the ISA should be taken as soon as possible after completion of the investigation.

During the test, candidates should work on their own and in silence. When candidates have completed the test the scripts must be collected. Teachers are required to mark the tests, using the marking guidelines provided by AQA. Tests should be marked in red ink with subtotals placed in the margin.

Teachers are expected to use their professional judgement in applying the marking guidelines: for example, applying it sensibly where candidates have given unexpected answers. When teachers have marked the scripts, they may tell candidates their marks but they must not return the scripts. Completed ISAs must be kept under secure conditions while the ISA is valid.

### Other guidance

Teachers' Notes will be put on to the AQA website prior to the ISAs becoming valid. ISA tests and marking guidelines will be published in advance.

If ISAs are to be used with different classes, centres must ensure security between sessions.

ISAs have specific submission dates. they may not be submitted in more than one year. The submission dates are stated on the front cover of each ISA.

Candidates may attempt any number of the ISAs supplied by AQA for a particular subject. The best mark they achieve from a complete ISA is submitted.

A candidate is only allowed to have **one** attempt at each ISA, and this may only be submitted for moderation on **one** occasion. It would constitute **malpractice** if the candidate is found to have submitted the same ISA more than once and they could be excluded from at least this qualification.

Specimen ISAs or ISAs that are no longer valid may be given to candidates so that they can practise the skills required. In these cases, candidates can be given back their completed and marked scripts. However, ISAs that are currently valid must **not** be given back to candidates.

## 3.7 Mathematical and other requirements

### Mathematical requirements

One learning outcome of this specification is to provide learners with the opportunity to develop their skills in communication, mathematics and the use of technology in scientific contexts. In order to deliver the mathematical element of this outcome, assessment materials for this specification contain opportunities for candidates to demonstrate scientific knowledge using appropriate mathematical skills.

The areas of mathematics that arise naturally from the science content in science GCSEs are listed below. This is not a checklist for each question paper or Controlled Assessment, but assessments reflect these mathematical requirements, covering the full range of mathematical skills over a reasonable period of time.

Candidates are permitted to use calculators in all assessments.

Candidates are expected to use units appropriately. However, not all questions reward the appropriate use of units.

All candidates should be able to:

- 1 Understand number size and scale and the quantitative relationship between units.
- 2 Understand when and how to use estimation.
- 3 Carry out calculations involving +, −, ×, ÷, either singly or in combination, decimals, fractions, percentages and positive whole number powers.
- 4 Provide answers to calculations to an appropriate number of significant figures.
- 5 Understand and use the symbols =, <, >, ~.
- 6 Understand and use direct proportion and simple ratios.
- 7 Calculate arithmetic means.
- 8 Understand and use common measures and simple compound measures such as speed.
- 9 Plot and draw graphs (line graphs, bar charts, pie charts, scatter graphs, histograms) selecting appropriate scales for the axes.
- 10 Substitute numerical values into simple formulae and equations using appropriate units.
- 11 Translate information between graphical and numeric form.
- 12 Extract and interpret information from charts, graphs and tables.
- 13 Understand the idea of probability.
- 14 Calculate area, perimeters and volumes of simple shapes.

In addition, Higher Tier candidates should be able to:

- 15 Interpret, order and calculate with numbers written in standard form.
- 16 Carry out calculations involving negative powers (only −1 for rate).
- 17 Change the subject of an equation.
- 18 Understand and use inverse proportion.
- 19 Understand and use percentiles and deciles.

### Units, symbols and nomenclature

Units, symbols and nomenclature used in examination papers will normally conform to the recommendations contained in the following:

- *The Language of Measurement: Terminology used in school science investigations*. Association for Science Education (ASE), 2010. ISBN 978 0 86357 424 5.
- *Signs, Symbols and Systematics – the ASE companion to 16–19 Science*. Association for Science Education (ASE), 2000. ISBN 978 0 86357 312 5.
- *Signs, Symbols and Systematics – the ASE companion to 5–16 Science*. Association for Science Education (ASE), 1995. ISBN 0 86357 232 4.

### Equation sheet

An equation sheet will be provided for each of the written units. Candidates will be expected to select the appropriate equation to answer the question.

# Scheme of Assessment

## 4.1 Aims and learning outcomes

GCSE specifications in physics should encourage learners to be inspired, motivated and challenged by following a broad, coherent, practical, satisfying and worthwhile course of study. They should encourage learners to develop their curiosity about the physical world, and provide insight into and experience of how science works. They should enable learners to engage with physics in their everyday lives and to make informed choices about further study in physics and related disciplines and about career choices.

GCSE specifications in physics must enable learners to:

- develop their knowledge and understanding of physics
- develop their understanding of the effects of physics and its applications on society
- develop an understanding of the importance of scale in physics
- develop and apply their knowledge and understanding of the nature of science and of the scientific process
- develop their understanding of the relationships between hypotheses, evidence, theories and explanations
- develop their awareness of risk and the ability to assess potential risk in the context of potential benefits
- develop and apply their observational, practical, modelling, enquiry and problem-solving skills and understanding in the laboratory and other learning environments
- develop their ability to evaluate claims based on science through critical analysis of the methodology, evidence and conclusions both qualitatively and quantitatively
- develop their skills in communication, mathematics and the use of technology in scientific contexts.





## 4.2 Assessment Objectives

The assessment units assess the following Assessment Objectives (AOs) in the context of the content and skills set out in Section 3 (Subject Content).

**AO1** Recall, select and communicate their knowledge and understanding of physics

**AO2** Apply skills, knowledge and understanding of physics in practical and other contexts

**AO3** Analyse and evaluate evidence, make reasoned judgements and draw conclusions based on evidence

### Weighting of Assessment Objectives for GCSE Physics M (modular)

The table below shows the approximate weighting of each of the Assessment Objectives in the GCSE units.

Assessment Objectives	Unit Weightings (%)				Overall weighting of AOs (%)
	1	2	3	4	
<b>AO1</b>	12.5	12.5	12.5	0	<b>37.5</b>
<b>AO2</b>	7.5	7.5	7.5	12.5	<b>35.0</b>
<b>AO3</b>	5.0	5.0	5.0	12.5	<b>27.5</b>
<b>Overall weighting of units (%)</b>	<b>25</b>	<b>25</b>	<b>25</b>	<b>25</b>	<b>100.0</b>

### Quality of Written Communication

In GCSE specifications that require candidates to produce written material in English, candidates must do the following:

- ensure that text is legible and that spelling, punctuation and grammar are accurate so that meaning is clear
- select and use a form and style of writing appropriate to purpose and to complex subject matter
- organise information clearly and coherently, using specialist vocabulary when appropriate.

In this specification Quality of Written Communication (QWC) is assessed in units 1, 2, 3 and 4 by means of longer response questions. These questions are clearly indicated in each question paper. In these questions, candidates cannot obtain full marks unless they address the three bullet points above.

## 4.3 National criteria

This specification complies with:

- the Subject Criteria for GCSE Physics including the rules for Controlled Assessment
- the Code of Practice
- the GCSE Qualification Criteria as they apply to non-English centres
- the Arrangements for the Statutory Regulation of External Qualifications in England, Wales and Northern Ireland: Common Criteria
- the requirements for qualifications to provide access to Levels 1 and 2 of the National Qualification Framework.

## 4.4 Previous Learning requirements

There are no previous learning requirements. However, any requirements set for entry to a course based on this specification are at your centre's discretion.

## 4.5 Access to assessment: diversity and inclusion

GCSEs often need to assess a wide range of competences. This is because they are general qualifications designed to prepare candidates for a wide range of occupations and further study.

The revised GCSE Qualification and Subject Criteria were reviewed to see whether any of the skills or knowledge needed by the subject presented a possible difficulty to any candidates, whatever their ethnic background, religion, sex, age, disability or sexuality. If there were difficulties, the situation was reviewed again to make sure that such tests of specific competences were only included if they were important to the subject. The findings were discussed with groups who represented the interests of a diverse range of candidates.

The Assessment Objectives do not assess the ability of students to see, speak, hear, read independently, handwrite, manipulate manually, perform physically, or to work in a team. The assessments allow the use of readers, scribes, practical assistants, word processors, transcripts, BSL/ISL signers, live speakers, MQ papers and extra time. For Controlled Assessment tasks, practical assistants may assist under instruction from the student. Arrangements are made for candidates with special needs to help them access the assessments as long as the competences being tested are not changed. Because of this, most candidates will be able to access any part of the assessment. Section 5.4 provides further details.

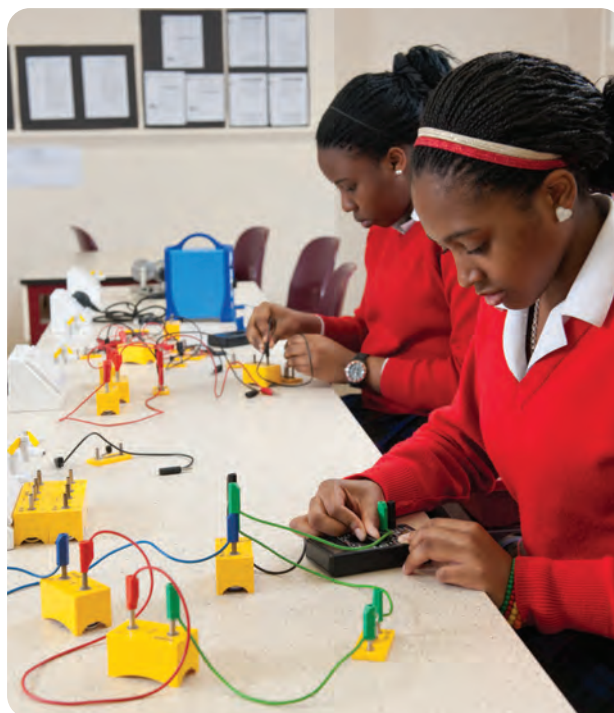



# Administration

## 5.1 Availability of assessment units and certification

Examinations and certification for this specification are available as follows.

	Availability of units				Availability of certification
	1	2	3	4	GCSE
January 2013	✓				
June 2013	✓	✓			
January 2014	✓	✓			
June 2014	✓	✓	✓	✓	✓

## 5.2 Entries

Please check the current version of *Entry Procedures and Codes* for up-to-date entry procedures. You should use the following entry codes for the units and for certification.

Unit 1 – MPH1FP or MPH1HP

Unit 2 – MPH2FP or MPH2HP

Unit 3 – MPH3FP or MPH3HP

Unit 4 – MPH4P

GCSE certification – 4603

The 40% terminal rule for GCSE means that 40% of the assessment must be taken in the examination series in which the qualification is awarded.

The results from 40% terminal assessment must contribute to the candidate's final grade, even if a candidate has a better result from a previous series.

Please note that entries are not allowed in the same examination series for the following combination of GCSE certifications:

- GCSE Physics M (modular) and GCSE Physics
- GCSE Physics M (modular) and GCSE Science A or GCSE Science M (modular)
- GCSE Physics M (modular) and GCSE Additional Science or GCSE Additional Science M (modular)

## 5.3 Private candidates

This specification is available to private candidates under certain conditions. Because of the Controlled Assessment, candidates must attend an AQA centre, which will supervise and mark the Controlled

Assessment. Private candidates should write to us for a copy of *Supplementary Guidance for Private Candidates* (for Controlled Assessment specification with practical activities).

---

## 5.4 Access arrangements, reasonable adjustments and special consideration

We have taken note of the equality and discrimination legislation and the interests of minority groups in developing and administering this specification.

We follow the guidelines in the Joint Council for Qualifications (JCQ) document: *Access Arrangements, Reasonable Adjustments and Special Consideration: General and Vocational Qualifications*. This is published on the JCQ website ([www.jcq.org.uk](http://www.jcq.org.uk)) or you can follow the link from our website [www.aqa.org.uk](http://www.aqa.org.uk)

### Access arrangements

We can arrange for candidates with special needs to access an assessment. These arrangements must be made **before** the examination. For example, we can produce a Braille paper for a candidate with sight problems.

### Reasonable adjustments

An access arrangement which meets the needs of a particular disabled candidate would be a reasonable adjustment for that candidate. For example a Braille paper would be a reasonable adjustment for a Braille reader but not for a candidate who did not read Braille. The Equality Act requires us to make reasonable adjustments to remove or lessen any disadvantage affecting a disabled candidate.

### Special consideration

We can give special consideration to candidates who have had a temporary illness, injury or serious problem such as the death of a relative, at the time of the examination. We can only do this **after** the examination.

The Examinations Officer at the centre should apply online for access arrangements and special consideration by following the e-AQA link from our website [www.aqa.org.uk](http://www.aqa.org.uk)

---

## 5.5 Examination language

We will only provide units for this specification in English.

---

## 5.6 Qualification titles

Qualifications based on this specification are:

- AQA GCSE in Physics M (modular).

## 5.7 Awarding grades and reporting results

This GCSE will be graded on an eight-grade scale: A\*, A, B, C, D, E, F and G. Candidates who fail to reach the minimum standard for grade G will be recorded as 'U' (unclassified) and will not receive a qualification certificate.

We will publish the minimum raw mark for each grade and for each unit when we issue candidates' results. We will report a candidate's unit results to your centre in terms of uniform marks and qualification results in terms of uniform marks and grades.

For each unit, the uniform mark corresponds to a grade as follows.

### Unit 1 Physics 1

(maximum uniform mark = 100)

Grade	Uniform Mark Range
A*	90–100
A	80–89
B	70–79
C	60–69
D	50–59
E	40–49
F	30–39
G	20–29
U	0–19

### Unit 2 Physics 2

(maximum uniform mark = 100)

Grade	Uniform Mark Range
A*	90–100
A	80–89
B	70–79
C	60–69
D	50–59
E	40–49
F	30–39
G	20–29
U	0–19

### Unit 3 Physics 3

(maximum uniform mark = 100)

Grade	Uniform Mark Range
A*	90–100
A	80–89
B	70–79
C	60–69
D	50–59
E	40–49
F	30–39
G	20–29
U	0–19

### Unit 4 Controlled Assessment

(maximum uniform mark = 100)

Grade	Uniform Mark Range
A*	90–100
A	80–89
B	70–79
C	60–69
D	50–59
E	40–49
F	30–39
G	20–29
U	0–19

We calculate a candidate's total uniform mark by adding together the uniform marks for the units. We convert this total uniform mark to a grade as follows.

### GCSE Physics M (modular)

(maximum uniform mark = 400)

Grade	Uniform Mark Range
A*	360–400
A	320–359
B	280–319
C	240–279
D	200–239
E	160–199
F	120–159
G	80–119
U	0–79

## 5.8 Grading and tiers

The Controlled Assessment is not tiered and the full range of grades A\*–G is available to candidates for this unit.

For the other units, candidates take either the Foundation Tier or the Higher Tier. For candidates entered for the Foundation Tier, grades C–G are available; for candidates entered for the Higher Tier, A\*–D are available. There is a safety net for candidates entered for the Higher Tier, where an allowed grade E will be awarded if candidates just fail to achieve grade D. Candidates who fail to achieve a grade E on the Higher Tier or grade G on the Foundation Tier will be reported as unclassified.

For the tiered units, candidates cannot obtain a Uniform Mark Scale (UMS) score corresponding to a grade that is above the range for the tier entered.

The maximum UMS score for candidates on a Foundation Tier written paper is 69. In other words, they cannot achieve a UMS score corresponding to a grade B. Candidates who just fail to achieve grade E on the Higher Tier paper receive the UMS score corresponding to their raw mark (ie they do not receive a UMS score of zero).

During the awarding procedures the relationship between raw marks and UMS score is decided for each tier separately. Where a grade is available on two tiers, for example grade C, the two raw marks chosen as the boundary for the grade on the two tiers are given the same UMS score. Therefore, candidates receive the same UMS score for the same achievement whether this is demonstrated on the Foundation or the Higher Tier assessments.

## 5.9 Re-sits and shelf life of results

Unit results remain available to count towards certification within the shelf life of the specification, whether or not they have already been used.

Candidates may re-sit a unit once only.

The better result for each unit will count towards the final qualification **provided that the 40% rule is satisfied**.

Candidates may re-sit the qualification an unlimited number of times.

Candidates will be graded on the basis of the work submitted for assessment.

Candidates must take units comprising at least 40% of the total assessment in the series in which they enter for certification.



# Controlled Assessment administration

The Head of Centre is responsible for making sure that Controlled Assessment work is conducted in line with our instructions and JCQ instructions.

## 6.1 Authentication of Controlled Assessment work

To meet the requirements of the Code of Practice, we need the following.

- **Candidates** must sign the Candidate Record Form to confirm that the work they have handed in is their own.
- **Teachers and assessors** must confirm on the Candidate Record Form that the work marked is only that done by that candidate and was conducted in line with the conditions in the specification document (authentication declaration).
- **Centres** must give a mark of zero if candidates cannot confirm the work handed in for assessment is their own.

You should attach the completed Candidate Record Form for each candidate to his or her work. All teachers who have marked the work of any candidate entered for each component must sign the declaration that the work is genuine.

If you have doubts about signing the authentication declaration, you should follow these guidance points.

- If you believe that a candidate had additional assistance and that this is acceptable within the guidelines for the relevant specification, you should award a mark which covers only the candidate's achievement without any help. (You should sign the authentication declaration and give information on the relevant form.)
- If you cannot sign the authentication declaration, the candidate's work cannot be accepted for assessment.

If, during the external moderation process, there is no evidence that the work has been authenticated, we will award a mark of zero.

## 6.2 Malpractice

You should let candidates know about our malpractice regulations.

Candidates must **not**:

- submit work that is not their own
- lend work to other candidates
- give other candidates access to, or the use of, their own independently sourced research material (this does not mean that candidates cannot lend their books to another candidate, but that candidates should be stopped from copying other candidates' research)
- include work copied directly from books, the internet or other sources without acknowledgement of the source
- hand in work typed or word-processed by someone else without acknowledgement.

These actions are considered malpractice, for which a penalty (for example being disqualified from the exam) will be applied.

If you suspect malpractice, you should consult your Examinations Officer about the procedure to be followed.

Where you suspect malpractice in Controlled Assessments after the candidate has signed the declaration of authentication, your Head of Centre must submit full details of the case to us at the earliest opportunity. The form JCQ/M1 should be used. Copies of the form can be found on the JCQ website [www.jcq.org.uk](http://www.jcq.org.uk)

Malpractice in Controlled Assessments discovered prior to the candidate signing the declaration of authentication need not be reported to us, but should be dealt with in accordance with your centre's internal procedures. We would expect you to treat such cases very seriously. Details of any work which is not the candidate's own must be recorded on the Candidate Record Form or other appropriate place.

---

## 6.3 Teacher standardisation

We will provide teacher standardisation opportunities for Controlled Assessment. Support will be provided in explaining tasks in context and using the marking criteria.

If your centre is new to this specification, you must complete teacher standardisation. If you have told us you are a new centre, either by sending us an *Intention to Enter* or an *Estimate of Entry*, or by contacting the subject team, we will contact you to invite you to provide details.

We will also contact centres in the following cases:

- if the moderation of Controlled Assessment work from the previous year has shown a serious misinterpretation of the Controlled Assessment requirements

- if a significant adjustment has been made to a centre's marks.

In these cases, you will also be expected to complete teacher standardisation. If you would like a copy of the written materials used at teacher standardisation, you should contact the subject administration team at **science-gcse@aqa.org.uk**

---

## 6.4 Internal standardisation of marking

Centres must have consistent marking standards for all candidates. One person must be responsible for ensuring that work has been marked to the same standard, and they need to sign the Centre Declaration Sheet to confirm that internal standardisation has taken place.

Internal standardisation may involve:

- all teachers marking some sample pieces of work and identifying differences in marking standards
- discussing any differences in marking at a training meeting for all teachers involved in the assessment
- referring to reference and archive material, such as previous work or examples from our teacher standardising meetings.

---

## 6.5 Annotation of Controlled Assessment work

The Code of Practice states that the awarding body must make sure that teachers marking Controlled Assessments clearly show how the marks have been awarded in line with the guidance provided. For this specification, the marking guidelines are provided by AQA and teachers must use the guidelines to annotate candidates' work.

Annotation includes:

- ticks and numbers showing how many marks have been awarded
- comments on the work that refer to the mark scheme.

Annotation helps our moderators to see as precisely as possible where the teacher has identified that candidates have met the requirements of the marking guidelines.



---

## 6.6 Submitting marks and sample work for moderation

The total mark for each candidate must be sent to us and the moderator (on the mark forms provided or electronically by Electronic Data Interchange (EDI) by the date given (see [www.aqa.org.uk/deadlines/coursework\\_deadlines](http://www.aqa.org.uk/deadlines/coursework_deadlines)). Our moderator will contact

you to let you know which pieces of work must be sent to them as part of the sample (please see Section 7.1 for more guidance on sending in samples).

---

## 6.7 Factors affecting individual candidates

You should be able to accept the occasional absence of candidates by making sure they have the chance to make up missed Controlled Assessments. (You may organise an alternative supervised time session for candidates who are absent at the time the centre originally arranged).

If work is lost, you must tell us immediately the date it was lost, how it was lost, and who was responsible. Inform our Centre and Candidate Support Services using the JCQ form *Notification of Lost Coursework JCQ/LCW form 15*.

Where special help that goes beyond normal learning support is given, use the Candidate Record Form to inform us so that this help can be taken into account during moderation.

Candidates who move from one centre to another during the course sometimes need additional help to meet the requirements of a scheme of Controlled Assessment work. How this can be dealt with depends when the move takes place. If it happens early in the course the new centre should be responsible for Controlled Assessment work. If it happens late in the course it may be possible to arrange for the moderator to assess the work as a candidate who was 'Educated Elsewhere'. Centres should contact us by e-mailing [science-gcse@aqa.org.uk](mailto:science-gcse@aqa.org.uk) as early as possible for advice about appropriate arrangements in individual cases.

---

## 6.8 Keeping candidates' work

From the time the work is marked, your centre must keep the work of all candidates, with Candidate Record Forms attached, under secure conditions, to allow the work to be available during the moderation

period or should there be an Enquiry about Results. You may return the work to candidates after the deadline for Enquiries about Results, or once any enquiry is resolved.

---

## 6.9 Grade boundaries on Controlled Assessment

The grade boundaries for the Controlled Assessment will be decided at the grade award meeting for each examination series and may, therefore, vary over time.



# Moderation

## 7.1 Moderation procedures

Controlled Assessment work is moderated by inspecting a sample of candidates' work sent (by post or electronically) from the centre to a moderator appointed by us. The centre marks must be sent to us and the moderator by the deadline given (see [www.aqa.org.uk/deadlines/coursework\\_deadlines](http://www.aqa.org.uk/deadlines/coursework_deadlines)). Centres entering fewer candidates than the minimum sample size (and centres submitting work electronically) should send the work of all of their candidates. Centres entering larger numbers of candidates will be told which candidates' work must be sent as part of the sample sent in for moderation.

Following the re-marking of the sample work, the moderator's marks are compared with the centre

marks to check whether any changes are needed to bring the centre's assessments in line with our agreed standards. In some cases the moderator may need to ask for the work of other candidates in the centre. To meet this request, centres must keep the Controlled Assessment work and Candidate Record Forms of every candidate entered for the examination under secure conditions, and they must be prepared to send it to us or the moderator when it is requested. Any changes to marks will normally keep the centre's rank order, but where major differences are found, we reserve the right to change the rank order.

## 7.2 Consortium arrangements

If you are a consortium of centres with joint teaching arrangements (where candidates from different centres have been taught together but where they are entered through the centre at which they are on roll), you must tell us by filling in the JCQ/CCA form *Application for Centre Consortium Arrangements for Centre-assessed Work*.

You must choose a consortium co-ordinator who can speak to us on behalf of all centres in the consortium. If there are different co-ordinators for different specifications, a copy of the JCQ/CCA form must be sent in for each specification.

We will allocate the same moderator to each centre in the consortium and the candidates will be treated as a single group for moderation.

## 7.3 Procedures after moderation

When the results are published, we will give centres details of the final marks for the Controlled Assessment work.

We will return candidates' work to you after the exam. You will receive a report, at the time results are issued,

giving feedback on any adjustments that were made to your marks.

We may keep some candidates' work for awarding, archiving or standardising purposes and will inform you if this is the case.

# Appendices

## A Grade descriptions

Grade descriptions are provided to give a general indication of the standards of achievement likely to have been shown by candidates who were awarded particular grades. The descriptions must be interpreted in relation to the content in the specification; they are not designed to define that content.

The grade awarded will depend in practice upon the extent to which the candidate has met the assessment objectives overall. Shortcomings in some aspects of candidates' performance in the assessment may be balanced by better performances in others.

### Grade A

Candidates recall, select and communicate precise knowledge and detailed understanding of physics. They demonstrate a comprehensive understanding of the nature of physics, its laws, principles and applications and the relationship between physics and society. They understand the relationships between scientific advances, their ethical implications and the benefits and risks associated with them. They use scientific and technical knowledge, terminology and conventions appropriately and consistently, showing a detailed understanding of scale in terms of time, size and space.

They apply appropriate skills, including communication, mathematical, technical and observational skills, knowledge and understanding effectively in a wide range of practical and other contexts. They show a comprehensive understanding of the relationships between hypotheses, evidence, theories and explanations and make effective use of models, including mathematical models, to explain abstract ideas, phenomena, events and processes. They use a wide range of appropriate methods, sources of information and data consistently, applying relevant skills to address scientific questions, solve problems and test hypotheses.

Candidates analyse, interpret and critically evaluate a broad range of quantitative and qualitative data and information. They evaluate information systematically to develop arguments and explanations, taking account of the limitations of the available evidence. They make reasoned judgements consistently and draw detailed, evidence-based conclusions.

### Grade C

Candidates recall, select and communicate secure knowledge and understanding of physics. They demonstrate understanding of the nature of physics, its

laws, principles and applications and the relationship between physics and society. They understand that scientific advances may have ethical implications, benefits and risks. They use scientific and technical knowledge, terminology and conventions appropriately, showing understanding of scale in terms of time, size and space.

They apply appropriate skills, including communication, mathematical, technical and observational skills, knowledge and understanding in a range of practical and other contexts. They show understanding of the relationships between hypotheses, evidence, theories and explanations and use models, including mathematical models, to describe abstract ideas, phenomena, events and processes. They use a range of appropriate methods, sources of information and data, applying their skills to address scientific questions, solve problems and test hypotheses.

Candidates analyse, interpret and evaluate a range of quantitative and qualitative data and information. They understand the limitations of evidence and use evidence and information to develop arguments with supporting explanations. They draw conclusions based on the available evidence.

### Grade F

Candidates recall, select and communicate limited knowledge and understanding of physics. They show a limited understanding that scientific advances may have ethical implications, benefits and risks. They recognise simple inter-relationships between physics and society. They use limited scientific and technical knowledge, terminology and conventions, showing some understanding of scale in terms of time, size and space.

They apply skills, including limited communication, mathematical, technical and observational skills, knowledge and understanding in practical and some other contexts. They recognise and use hypotheses, evidence and explanations and can explain straightforward models of phenomena, events and processes. Using a limited range of skills and techniques, they answer scientific questions, solve straightforward problems and test ideas.

Candidates interpret and evaluate limited quantitative and qualitative data and information from a narrow range of sources. They can draw elementary conclusions having collected limited evidence.

## B Spiritual, moral, ethical, social, legislative, sustainable development, economic and cultural issues, and health and safety considerations

We have taken great care to make sure that any wider issues (for example, spiritual, moral, ethical, social, legal, sustainable development, economic and cultural issues), including those relevant to the education of candidates at Key Stage 4, have been taken into account when preparing this specification. They will only form part of the assessment requirements where they are relevant to the specific content of the specification. In Section 3 (Subject Content), aspects of the wider issues that may be assessed are introduced with the phrase: 'Candidates should use their skills, knowledge and understanding to:'. Additionally, health and safety considerations are addressed in the Controlled Assessment.

### **European Dimension**

We have taken the 1988 Resolution of the Council of the European Community into account when preparing this specification and associated specimen units.

### **Environmental Education**

We have taken the 1988 Resolution of the Council of the European Community and the Report *Environmental Responsibility: An Agenda for Further and Higher Education* (1993) into account when preparing this specification and associated specimen units.

### **Avoiding Bias**

We have taken great care to avoid bias of any kind when preparing this specification and specimen units.

## C Overlaps with other qualifications

The Unit 1 content of GCSE Physics M (modular) is contained within GCSE Science A and GCSE Science M (modular).

The Unit 2 content of GCSE Physics M (modular) is contained within GCSE Additional Science and GCSE Additional Science M (modular).

GCSE Physics M (modular) covers identical content to GCSE Physics.

## D Wider Key Skills

### **The replacement of Key Skills with Functional Skills**

The Key Skills qualifications have been replaced by Functional Skills ([web.aqa.org.uk/qual/functional-skills](http://web.aqa.org.uk/qual/functional-skills)).

Students following a course of study based on this specification for GCSE Physics M (modular) can be offered opportunities to develop and generate evidence of attainment in aspects of the Functional Skills.

### **Basic Skills Adult Literacy Levels 1 and 2, Adult Numeracy Levels 1 and 2**

AQA Basic Skills qualifications will now be available until, at least, the June 2012 series. If you would like to check the funding provision, please contact the Skills Funding Agency:

[info@skillsfundingagency.bis.gov.uk](mailto:info@skillsfundingagency.bis.gov.uk)

0845 377 5000.

### **Wider Key Skills**

Students following a course of study based on this specification for GCSE Physics M (modular) can be offered opportunities to develop and generate evidence of attainment in aspects of the Wider Key Skills of:

- Working with others
- Improving own learning and performance
- Problem solving.

The AQA Wider Key Skills qualifications are no longer available.

## GCSE Physics M (modular) Specification

For exams January 2013 onwards

For certification June 2014

---

**Qualification Accreditation Number: 600/7117/5**

---

Centres should be aware that candidates who enter for more than one GCSE qualification with the same classification code will have only one grade counted for the purpose of the School and College Performance Tables. In the case of a candidate taking two qualifications with the same classification code that are of the same size and level, eg two full course GCSEs, the higher grade will count.

Centres may wish to advise candidates that, if they take two specifications with the same classification code, schools and colleges are very likely to take the view that they have achieved only one of the two GCSEs.

The same view may be taken if candidates take two GCSE specifications that have different classification codes but have significant overlap of content. Candidates who have any doubts about their subject combinations should check with the institution to which they wish to progress before embarking on their programmes.

To obtain specification updates, access our searchable bank of frequently asked questions, or to ask us a question, register with Ask AQA: [aqa.org.uk/ask-aqa/register](http://aqa.org.uk/ask-aqa/register)

You can also download a copy of the specification and support materials from our website: [sciencelab.org.uk/subjects](http://sciencelab.org.uk/subjects) for all your subject resources.